

E-Series Battery User Manual



2023.05 Version 1.2

Copyright © 2023 ePropulsion. All Rights Reserved

Acknowledgement

Thanks for choosing ePropulsion products, your trust and support in our company are sincerely appreciated. We are dedicated to providing high-performance electric outboards, electric outboards, sup/kayak motors, reliable lithium batteries and accessories.

Welcome to visit www.epropulsion.com and contact us if you have any concerns.

Using This Manual

Before use of the product, please read this user manual thoroughly to understand the correct and safe operations. By using this product, you hereby agree that you have fully read and understood all contents of this manual. ePropulsion accepts no liability for any damage or injury caused by operations that contradict this manual.

Due to ongoing optimization of our products, ePropulsion reserves the rights of constantly adjusting the contents described in the manual. ePropulsion also reserves the intellectual property rights and industrial property rights including copyrights, patents, logos and designs, etc.

This manual is subject to update without prior notice, please visit our website www.epropulsion.com for the latest version. If you find any discrepancy between your products and this manual, or should you have any doubts concerning the product or the manual, please visit www.epropulsion.com.

ePropulsion reserves the rights of final interpretation of this manual.

This manual is multilingual, in case of any discrepancy in the interpretation of different language versions, the English version shall prevail.

Symbols

The following symbols will help to acquire some key information.

 Important instructions or warnings

 Useful information or tips

Product Identification

Below figure indicates the position of the product label on which the serial number is located. Please record the serial number for access to maintenance or other after-sale services.

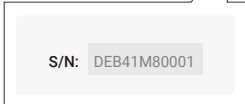
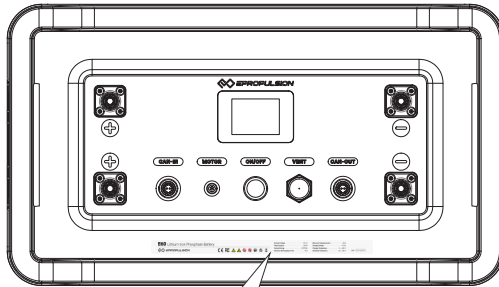

Table of Contents

- Acknowledgement..... 1**
- Using this manual..... 1**
- Symbols 1**
- Product Identification 2**
- 1 Product Overview 4**
 - 1.1 In the Package 4
 - 1.2 Parts and Diagram 5
 - 1.3 Specifications 6
 - 1.4 Instructions before Use 6
 - 1.5 Important Instructions..... 8
 - 1.6 Declaration of Conformity 8
- 2 Operation..... 10**
 - 2.1 Check the Battery Status..... 10
 - 2.2 Using the Battery..... 10
 - 2.2.1 Connecting the Battery to the Machine..... 11
 - 2.2.2 Turning on/off the Battery..... 12
 - 2.2.3 Charging the Battery..... 13
 - 2.3 Using Multiple Batteries 13
 - 2.3.1 Connecting Batteries in Parallel 13
 - 2.3.2 Connecting Parallel Batteries to the Machine 14
 - 2.3.3 Turning on/off the Batteries in Parallel 15
 - 2.4 Display 15
 - 2.5 Buzzer 17
- 3 Troubleshooting 18**
- 4 Transportation and Storage 20**
 - 4.1 Transportation..... 20
 - 4.2 Storage 20
 - 4.3 Disposal and environment 21
- 5 Routine Maintenance..... 22**
- 6 Warranty 23**
 - 6.1 Out of Warranty 24
 - 6.2 Limited Warranty Claim Procedures..... 25

1 Product Overview

ePropulsion E-Series Battery is a lithium iron phosphate battery with good safety performance, high energy density, long cycle life and high reliability. E-Series Battery includes two models, E60 and E163, with a nominal voltage of 51.2V and a capacity of 60Ah and 163Ah.

1.1 In the Package







Save the ePropulsion original package for the battery storage.



Other accessories mentioned in this user manual need to be purchased by users from ePropulsion authorized dealers.

Unpack the package and check if there is any damage caused during transport. Check all the items inside the package against the below list. If there is any transport damage or lack of any listed item, please contact your dealer immediately.

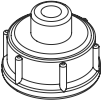
Items	Qty./Unit	Figure
E-Series Battery	1 Set	
User Manual	1 pcs	
Rubber plug	4 pcs	
CAN communication port waterproof cover	2 pcs	
Motor communication port waterproof cover	1 pcs	

1.2 Parts and Diagram

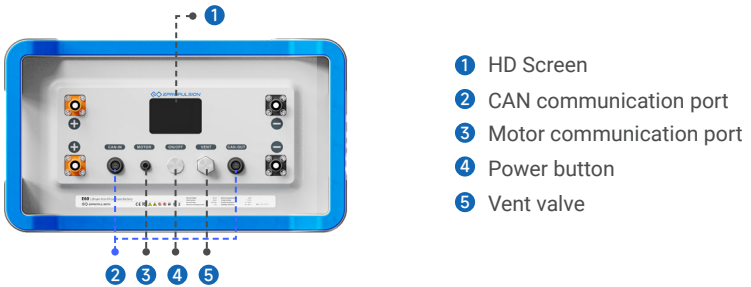

Figure 1-1

- CAN-IN port can be connected with E battery remote switch or E battery communication terminator.
- CAN-OUT port can be connected with the charger or E battery communication terminator.

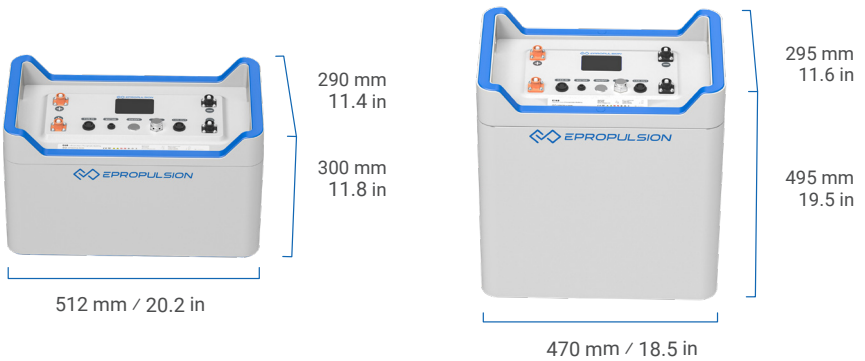

Figure 1-2

1.3 Specifications

	E60	E163
Chemistry	Lithium iron phosphate battery	
Capacity	3072 Wh / 60 Ah	8345 Wh / 163 Ah
Rated voltage	51.2 V	
Final charging voltage	57.6 V	
Cut-off voltage	41.6 V	
Maximum charging current	60 A	150 A
Max continuous discharging current	70 A	150 A
Parallel connection	Max 16 E-Series Batteries on the same model	
Serial Connection	Not support	
Storage temperature	-20~45°C three mouths -10~25°C six mouths	
Recommended Charging Temperature	0 ~ 55°C (32 ~ 131°F)	
Recommended Discharging Temperature	-10 ~ 60°C (14 ~ 140°F)	
Dimensions	512 x 290 x 300 mm (20.2 x 11.4 x 11.8 in)	470 x 295 x 495 mm (18.5 x 11.6 x 19.5 in)
Weight	33 kg	76 kg
Recommended battery level during storage	45%~50%	
Recommended Mounting Position	Upright (display up)	Upright (display up) or either long side (logo up)

1.4 Instructions before Use

- Before using the battery, please read the user manual carefully. Only adults who have fully read and understood this manual are allowed to operate this product.
- Before each use, check if the battery is firmly fixed, and check the condition, functionality and connection of the battery.

- Due to transportation and storage requirements, the battery is shipped half full. It is recommended to fully charge the battery before the first use.
- Avoid battery short-circuit during connection, do not disassemble the battery.
- Do not store the battery in a damp environment.
- During use, keep away from an external heat source and high voltage equipment.
- Do not exposure to shock or excessive vibrations.
- During use, when a fault occurs, please check the alarm code on the display and troubleshoot the corresponding alarm code table.
- It is not recommended to stack batteries.
- Used batteries should be disposed of according to local laws and regulations.

1.5 Important Instructions

- When the battery is not in use, make sure that the battery's connectors are covered well with the waterproof caps.
- Before connecting the E battery with the third party product, please contact ePropulsion authorized distributor.
- The capacity of the battery is obtained under the relevant standard conditions, and the actual capacity under different temperatures or charging and discharging conditions will be different from the nominal capacity.
- E-Series Battery is splash, water, and dust resistant and was tested before delivery with a rating of IP67. Splash, water, and dust resistance are not permanent conditions and resistance might decrease as a result of normal wear. Liquid damage is not covered under warranty.
- Do not put the battery in trash that is disposed of in landfills. When disposing of the battery, comply with local laws or regulations.
- Do not immerse or splash the battery in water.
- Ensure the battery can never cause a short via jewellery or tools.
- Do not exposure to shock or excessive vibrations.
- Only use certified chargers supplied by qualified manufacturers.
- Do not subject the battery to significant damage.
- Never touch a leaking battery or cell.
- Never mix up the positive terminals with negative terminals.
- Do not short circuit, overcharge or over discharge the battery.
- Never connect batteries in series.

- It is strictly prohibited to mix this battery with different types or specifications of batteries in parallel.
- If the battery is used in extreme environments (below 0°C or above 50°C), the battery life will be shortened.
- Charge the battery in the place that is safe, dry and free of flammable materials.
- When the battery is not used for an extended period of time, make sure the battery level is around 45%~50% before storing.
- Do not use conductive materials like metal that could cause a short circuit.
- Please keep the battery in a cool and dry place.
- Keep the battery away from children.
- Do not place the battery in direct sunlight.
- Never open the battery case. If the case is damaged, do not use, charge or discharge the battery. Please contact ePropulsion authorized distributor.
- Do not attempt to disassemble, repair or modify the product, as this may cause fire or even completely damage the product.
- Do not disassemble, puncture or crush the product nor expose it to fire. Disposal of a battery into fire or a hot oven or water or other liquids or mechanically crushing or cutting of a battery, that can result in an explosion.
- Leaving a battery in an extremely high temperature surrounding environment that can result in an explosion or the leakage of flammable liquid or gas.
- A battery subjected to extremely low air pressure that may result in an explosion or the leakage of flammable liquid or gas.
- Replacement of a battery with an incorrect type that can defeat a safeguard (such as catching fire, explosion, leakage of corrosive electrolyte etc).

1.6 Declaration of Conformity

Object of the Declaration:

Product: Lithium-ion Battery Pack

Model: E60, E163



We Guangdong ePropulsion Technology Co., Ltd., hereby, declares that this equipment is in compliance with the applicable Directives and European Norms, and amendments. The full text of the EU declaration of conformity is available at the following internet address:
<http://yachter123.com/sy>

The object of the declaration is in conformity with the following directives:

Electromagnetic Compatibility (EMC) Directive	2014/30/EU
Low Voltage Directive	2014/35/EU

Applied Standards:

- EN IEC 61000-6-3: 2021
- EN IEC 61000-3-2: 2019+A1:
- EN 61000-3-3: 2013+A1:2019+A2:2021
- EN IEC 61000-6-1: 2019
- EN 60335-1:2012+A11:2014+A13:2017+A1:2019+A14:2019+A2:2019+A15:2021
- EN 62233:2008
- AS/NZS 61000.6.3:2021
- BS EN IEC 61000-6-3: 2021
- BS EN IEC 61000-3-2: 2019+A1:2021
- BS EN 61000-3-3: 2013+A1:2019+A2:2021
- BS EN IEC 61000-6-1: 2019
- BS EN 60335-1:2012+A11:2014+A13:2017+A1:2019+A14:2019+A2:2019+A15:2021
- BS EN 62233:2008

This device complies with part 15 of the FCC Rules: Operation is subject to the following two conditions:

1. This device may not cause harmful interference and,
2. This device must accept any interference received, including interference that may cause undesired operation.

Manufacturer

Name: Guangdong ePropulsion Technology Limited

Address: Room 801, Building 1, 11 Daxue Road, Songshan Lake, Dongguan, Guangdong Province, China

Signature: 

Date: 2nd of June, 2023

Shizheng Tao, Chief Executive Officer & Cofounder of
Guangdong ePropulsion Technology Limited

2 Operation

2.1 Check the Battery Status

- ⚠** Do not remove the masking tape or plug from the battery. The masking tape can prevent customers from being strangled by the structure when picking up the battery, and prevent the battery from the water.
- ⚠** Please avoid direct contact with water or continuous exposure to sunlight.



- 💡** If the alarm indicator is on, refer to Section 2.4 Display, Section 2.5 Buzzer, and Section 3 Troubleshooting to deal with the problems. During this operation, the battery has no output.
- 💡** During this operation, please cut off the output.

2.2 Using the Battery

2.2.1 Connecting the Battery to the Machine

- ⚠** When connecting the power cables, please pay attention to the positive and negative terminals. Never mix up the positive terminals with negative terminals.
- ⚠** Avoid battery short-circuit during connection.
- ⚠** When connecting, insert the power plug into place and hear a "click" sound to avoid false connection of the battery.
- ⚠** If it is connected to ePropulsion outboard motor, and the power cable or communication cable is abnormally connected, the outboard motor will stop.

Before connecting the battery to the machine (outboard, etc.), make sure that the battery power button is turned off and follow these steps:

1. Connect the power cable of the machine to the battery.
2. If connecting to an epropulsion outboard motor, in order to better obtain power information, please correctly connect the machine and battery with the communication cable of the outboard motor. If connecting with the control system by wire, please connect with the communication cable of the control system (refer to figure 2-1).



Y-type communication cable can be connected with the motor communication port on the battery or the communication port of the outboard motor.

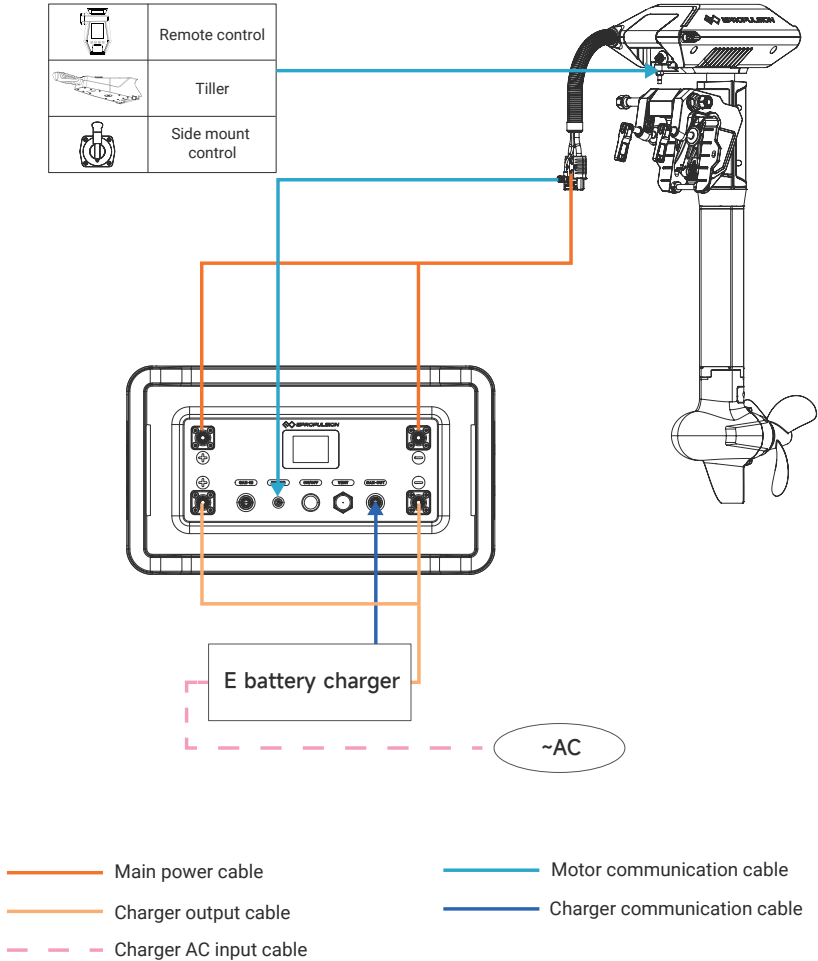

Figure 2-1

2.2.2 Turning on/off the Battery



The battery has an auto sleep function. After the battery is turned on, if no operation or use is carried out within 7 days, the battery will automatically turn off.



Before turning on the battery, please make sure that the power cable of the machine is securely connected to the battery, the connection is locked and there is no risk of slipping, and there is no short circuit.

a. Using the power button on the battery

1. For turning on the battery, please press and hold the power button on the battery for 1 second (no more than 3 seconds). The display will illuminate, the battery will start and self-check. If there is no warning, it means the battery is turned on successfully.
2. For turning off the battery, please press and hold the power button on the battery for 3 seconds, then the battery will turn off automatically.

b. Using E battery remote switch



The remote switch can only be connected to the CAN-IN port. Do not connect to the CAN-OUT port.



When using the remote switch, there is no need to operate the power button on the battery. Using either switch can control the switching on or off of the battery.



Remote switches need to be purchased separately.

When using an ePropulsion E battery remote switch, please connect the remote switch with the CAN-IN port according to the following figure, then operate the remote switch.

- ① Fix the remote switch.
- ② Connect the remote switch to the battery CAN-IN port.

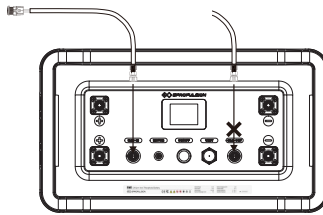











Figure 2-2

1. To turn on the battery, please press and hold the power button on the remote switch for 1 second (no more than 3 seconds). The display will illuminate. The battery will start and self-check. If there are no warnings, it means the battery is really for use.
2. To turn off the battery, please press and hold the power button on the remote switch for 3 seconds, you can see the indicators on the remote and battery are off.

2.2.3 Charging the Battery

Please read the following notices before charging:

-  Please use the ePropulsion charger specially designed for E-Series Batteries to charge the battery. If using a three party MPPT, please contact an authorized ePropulsion dealer.
-  The charger's communication cable needs to be connected to the battery's CAN-OUT port.
-  Please make sure that the AC power is turned off before charging.
-  Never mix up the positive terminals with negative terminals.
-  Only charge the battery at 0 ~ 55°C.
-  When charging, keep the battery away from water and avoid direct sunlight or rain. Charge the battery in the dry, ventilated place.
-  Avoid direct contact with the charger when in use, the charger can get to a high temperature.
-  Please do not overcharge the battery.
-  Keep the battery away from children.

①When charging the battery, connect the charger's power cable to the positive and negative terminals of the battery. The positive terminal of the charger's power cable is connected with the positive terminal of the battery, and the negative terminal of the charger's power cable is connected with the negative terminal of the battery. Then connect the communication cable from the charger to the battery CAN-OUT port. Make sure that the connection is correct.



②After confirming that the battery is turned off, connect the charger to AC power, and then press the power button on the battery/remote switch to turn on the battery. If the system has no alarms, indicating that the battery is successfully charging.

③After the charging is completed, long press the power button on the battery/remote switch, then unplug the power plug of the charger, and then release the connection with the battery charger.

2.3 Using Multiple Batteries



-  Do not connect batteries in series.

2.3.1 Connecting Batteries in Parallel

-  **Must connect the batteries in parallel when the batteries are fully charged, and the voltage difference must not exceed 2V.**
-  When batteries are connected in parallel, the battery's CAN-IN port must be connected to a remote switch or a communication terminator (purchased separately)

Connecting two or more batteries in parallel can will expand their capacity. E-Series Batteries support up to 16 batteries of the same type in parallel. Use battery bridging cables and E battery communication cables (purchased separately) to connect the batteries. Use the E battery communication cable to connect the CAN-OUT port of the 1# battery (refer to figure 2-5) and the CAN-IN port of the 2# battery and so on. Please refer to the figure below.

2.3.2 Connecting Parallel Batteries to the Machine

-  When the parallel batteries are connected to the ePropulsion outboard motor, it needs to connect the outboard motor to 1# battery with the communication cable (refer to figure 2-6). And the outboard motor can only be connected with 1# battery.
-  When connected in parallel, the CAN-IN port must be connected to a remote switch or a communication terminator.

Refer to Section 2.2.1 to connect the 1# battery to the machine. The figure below is the connection between the parallel batteries and ePropulsion outboard motor.

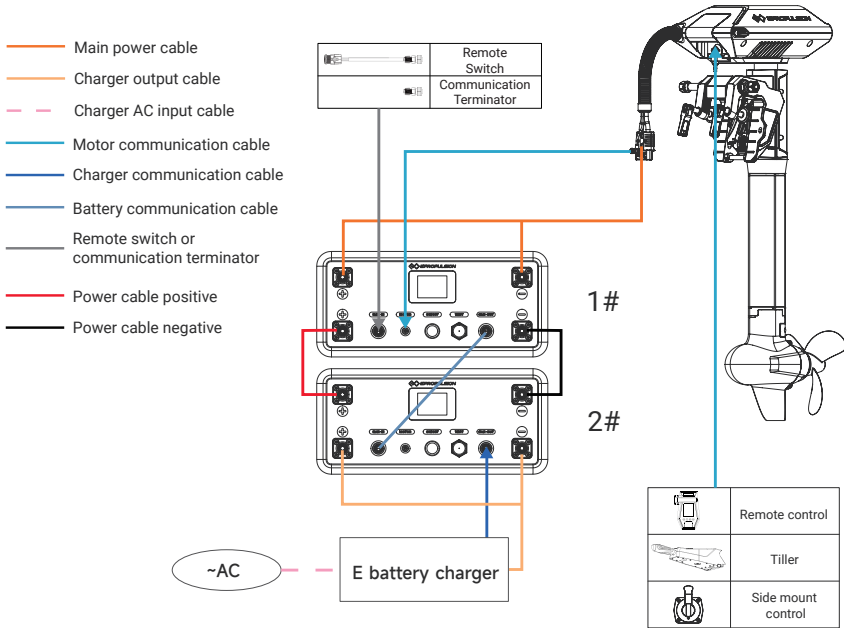





Figure 2-3

-  The maximum continuous discharging current of the battery is 70A (E60)/150A (E163). Only the machine with load current less than this value can be connected.
-  If the batteries are connected in parallel, the discharging current range will increase.
-  If the discharging current is exceeded, the fuse of the battery may be blown.

2.3.3 Turning on/off the Batteries in Parallel

 When multiple batteries of the same model are connected in parallel, you can only press the power button on the 1# battery (the battery connects to the machine, refer to figure 2-6) or the remote switch to turn on/off the batteries.

1. To turn on the batteries, please press and hold the power button on the 1# battery or the remote switch. The displays of the batteries will light up one after another. After all of them are lit, release the button (no more than 5 seconds). The battery will start and self-check. If there are no warnings, it means the battery is really for use.

2. To turn off the batteries, please press and hold the power button on the 1# battery or the remote switch for 3 seconds, you can see the indicators on the remote and batteries are off.



After the battery is powered on, the battery's BMS and relay will consume the power of the battery itself. When the battery is not used for a long time, please turn off the battery power in time.

2.4 Display

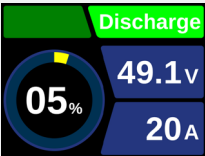
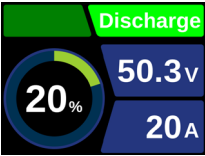
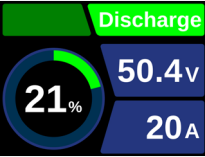
Battery Condition	Description	Error Code	Detail	Figure	Alarm	Running
Shut-down	Display lights off			/		×
Dis-charging	Battery level alarm 1		Battery level 0~5%			✓
	Battery level alarm 2		Battery level 6~20%			✓
	Normal battery level		Battery level 21~100%			✓

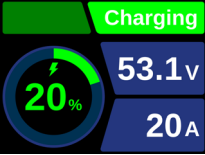
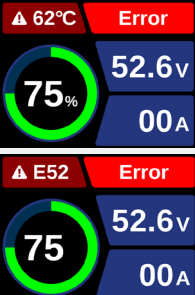
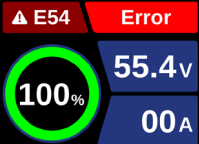
Battery Condition	Description	Error Code	Detail	Figure	Alarm	Running
Charging	The lightning icon flashes and the SOC font turns green		Battery level 0~100%			√
Warning	Charging over temperature alarm, voltage alarm, voltage alarm	E51	Temperature and error code show alternately		√	×
	Discharging over temperature alarm	E52			√	×
	Charging over voltage alarm	E54			√	×
	Discharging under voltage alarm	E55		Below are similar	√	×
	Battery over current alarm	E57			√	×
Relay sticking fault	E62			√	×	
Fuse blown fault	E63			√	×	
Parallel fault	E64			√	×	

Battery Condition	Description	Error Code	Detail	Figure	Alarm	Running
Warning	Cable fault	E65			√	×
	Differential voltage alarm	E66			√	×
	Multiple warning		The error codes display in turn.	/	√	×

2.5 Buzzer

Buzzer status	Description
Beep for 8 seconds	The battery has warnings, please refer to Section 2.4, and Section 3 for troubleshooting.

3 Troubleshooting

Error code	Description	Solution
E54	Overvoltage	<ol style="list-style-type: none"> 1. Check whether the battery is fully charged. If the battery is fully charged, it is normal for the battery to overvoltage. 2. If the battery is not fully charged, but an over-voltage protection occurs, please contact an authorized ePropulsion dealer.
E51/ E52	Charge/discharge over temperature	<ol style="list-style-type: none"> 1. Disconnect the charger/machine. 2. If the temperature is too high, cool the battery. After the temperature decreases, restart the battery. Please operate the battery at a suitable temperature. 3. If the temperature is too low, please use the battery at an appropriate temperature. 4. If the fault persists, please contact an authorized ePropulsion dealer.
E55	Discharge undervoltage	<ol style="list-style-type: none"> 1. Stop discharging. 2. Charge the battery. 3. If the fault persists, please contact an authorized ePropulsion dealer.
E57	Discharge overcurrent	<ol style="list-style-type: none"> 1. Disconnect the machine. 2. Restart the battery, and check. If the fault persists, please contact an authorized ePropulsion dealer. If the fault does not persist, check the external circuitry for short-circuit or whether to connect with the high-current load. 3. If the fault persists, please contact an authorized ePropulsion dealer.
E63	Fuse fault	<ol style="list-style-type: none"> 1. Check whether the battery and external cable are short-circuited 2. If there is no short circuit, disconnect all connections to the battery. Then restart the battery after a while, and see if the fault persists. 3. If the fault persists, please contact an authorized ePropulsion dealer.
E62	Relay fault	<ol style="list-style-type: none"> 1. Check if the battery is connected with other devices. 2. Disconnect all connections to the battery. Then restart the battery after a while, and see if the fault persists. 3. If the fault persists, please contact an authorized ePropulsion dealer.

Error code	Description	Solution
E65	cable fault	<ol style="list-style-type: none"> 1. Disconnect all connections to the battery. Then restart the battery after a while, and see if the fault persists. 2. If the fault persists, please contact an authorized ePropulsion dealer.
	No response by pressing the power button	<ol style="list-style-type: none"> 1. Read the user manual, and confirm whether the operation is correct. 2. If the fault persists, please contact an authorized ePropulsion dealer.
	The battery has no input or output	<ol style="list-style-type: none"> 1. Check the connection between the battery, charger and the machine. 2. Reconnect the communication cables and power cables. 3. Disconnect the machine or charger, and reconnect after a while. 4. Contact an authorized ePropulsion dealer.
	Other faults	<ol style="list-style-type: none"> 1. Disconnect all connections to the battery. Then restart the battery after a while, and see if the fault persists. 2. If the fault persists, please contact an authorized ePropulsion dealer.

4 Transportation and Storage

4.1 Transportation

- ⚠ Check and ensure the package is intact without any damage.
- ⚠ Avoid violent vibration, strike or squeeze during transport. Get adequate damping protection measures before transport.
- ⚠ Do not expose the battery to the sun or rain during transport.
- ⚠ Check applicable local, national or international laws and regulations before transport.

The below figure displays how to pack the battery with ePropulsion original packing material. For long-distance transport, it's recommended to apply ePropulsion original package to pack the outboard before delivery.

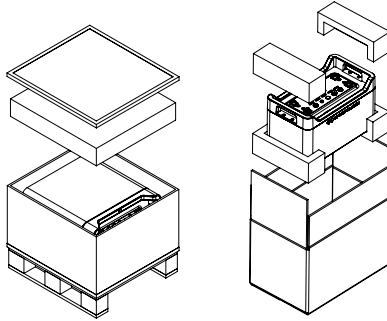

4.2 Storage

- 💡 When the battery is not in use, make sure that the battery's connectors are covered well with the waterproof caps.
- 💡 Disconnect all connections to the battery and check that all connectors are clean.
- 💡 Before storage, make sure the battery level is around 45%~50%, and stored at an ambient temperature of 15°C ~ 25°C, relative humidity not more than 75%, clean, dry and ventilated place, to avoid contact with corrosive contact, away from fire and heat sources.
- 💡 Protect against moisture, dust, water, shock and heat.
- 💡 Every 3 months of storage, the battery should be recharged with an appropriate ePropulsion charger.

4.3 Disposal and environment



All products bearing this symbol are waste electrical and electronic equipment (WEEE as in directive 2012/19/EU) which should not be mixed with unsorted household waste. Instead, you should protect human health and the environment by handing over your waste equipment to a designated collection point for the recycling of waste electrical and electronic equipment, appointed by the government or local authorities. Correct disposal and recycling will help prevent potential negative consequences to the environment and human health. Please contact the installer or local authorities for more information about the location as well as terms and conditions of such collection points.

5 Routine Maintenance

Various factors like operation environment (such as temperature, humidity, dust, etc.), aging and wear of internal components, will increase the possibilities of battery failure. In order to avoid this, keep your battery in optimal operating state, and eventually extend the service lifespan of the battery. Therefore, routine maintenance is very important.

- Before long-term storage, please disconnect the communication cable and the power cable between batteries and machines.
- Before the first time use or reuse after long-term storage, charge the battery to its full capacity in order to achieve the best performance. Only use ePropulsion charger designed for E-Series Battery to charge the battery. Other chargers may lead to reduced battery capacity, premature battery failure, fire or explosion. Avoid over-charging, which may cause fire or explosion.
- Use the battery in moderate temperature to avoid negative effects of extreme temperature posed on battery lifespan and useful cycles.
- If a fault occurs, deal with the problem in a timely manner to avoid any further damage. If necessary, consult the ePropulsion authorized dealer for repair or parts replacement.
- During storage, strictly follow the instructions in Section 4.2 Storage. Pay special attention to the residual charge and check the battery state in a regular manner.
- Use a clean & dry towel to keep the battery surface away from oil, dirt and water. Avoid touching metal contacts. All the contacts need to be kept clean for best performance.
- When carrying batteries around, do not touch the contacts with metal objects such as keys or tools to avoid short circuit, battery damage, and potential fire or explosion.
- To improve functionality and prolong lifespan of the battery, avoid direct sunshine or radiation exposure. Meanwhile, avoid liquid, dust or dirt entering the battery.
- Do not leave the battery at a low state of charge.
- It is advised to check the battery state of charge on a regular basis.
- Clean all electrical contacts with electrical contacts cleaner, e.g. WD40, every two months, and clean immediately once there is rusty show up or splashed with sea water. And for long-term storage, please use conductive gel to protect electrical pins.

6 Warranty

Guangdong ePropulsion Technology Co., Ltd. (“ePropulsion”), China, warrants its products to be free of defects in material and workmanship under normal usage with proper installation and routine maintenance for a period of twenty-four (24) months from date of delivery of products to end customers (the “Limited Warranty Period”). The Limited Warranty is provided to the first end customer of ePropulsion products ONLY. The Customer is entitled to free repair or replacement of defective or non-conform parts. Any warranty claim must be made within six (6) months of discovery of issues as provided below.

If the Limited Warranty Period expires, you can still enjoy maintenance services from dealers/distributors authorized by ePropulsion (the “ePropulsion Service Partners”) with minimum maintenance charge per occurrence.

In all warranty cases, ePropulsion will only bear the repair cost and other costs (such as those related to product installation, disassemble, transportation, financing, rental, etc.) as a direct result for issues covered by the Limited Warranty only. Any costs irrelevant to or out of the scope of the Limited Warranty will be born by the Customer alone., which shall NOT include costs irrelevant such as those related to product installation, disassemble, transportation, financing, rental, etc.

Beyond the Limited Warranty, the Customer may have statutory rights in your jurisdiction according to applicable laws. Nothing in this Limited Warranty affects such rights. The Customer may have warranty claim rights arising from the purchase contract with ePropulsion Service Partners in addition to the rights granted by this Limited Warranty.

Products for commercial/professional use, even if only temporarily, are not covered by the Limited Warranty. Instead, the statutory warranty in your jurisdiction shall apply. You are encouraged to consult with ePropulsion Service Partners for applicable warranty and advice before engaging in such use.

*** Commercial/professional Use refers to application cases that have high use frequency, high-reliability requirement or aim for money making, etc.**

To keep your warranty valid, you shall follow:



Keep the product label intact and record the Serial Number shown on the label. Never tear the label off the product. A product without the original product label is not covered by the Limited Warranty provided by ePropulsion;



The Limited Warranty is not transferable and will not be reissued;



The Limited Warranty may change from time to time. Pls visit our website (<http://www.epropulsion.com>) for the latest version.

6.1 Out of Warranty

ePropulsion may refuse a warranty claim if:

- Any improper operation contradicts what is written in the user manual;
- Accident, misuse, dropping, improper care or storage, willful abuse, physical damage, overcharging, over discharging, or unauthorized repair;
- Water ingress caused by external sources such as fishing nets, submerging underwater, etc;
- Product modification, alternation, disassembly, or parts/accessories attachment, which are not expressly permitted or recommended by ePropulsion;
- Failure of, or damage caused by, any 3rd party products;
- Consumables are out of warranty scope (like propeller, anode...etc.);
- Purchases of product from unauthorized dealers or seller;
- Normal wear and tear and routine servicing are excluded from the warranty;
- The product gets further damaged due to improper packing during delivery. The further damaged part will be deemed as out of warranty coverage;
- Lithium battery is classified as a UN9 hazardous item, posting and packing must be in accordance with the relevant law of the local country directive. Non-compliance may result in out of warranty coverage.

6.2 Limited Warranty Claim Procedures

The Customer shall follow the warranty claim process to make a Limited Warranty claim:

1. Contact your nearest ePropulsion Service Partners and they will provide further instruction to you if such defects are covered by the Limited Warranty or theirs.
2. Send the defective product to them together with Proof of 1(st)-time Purchase (e.g., receipt, invoice, etc., with information of product purchased and date of purchase), the Confirmation of Online Warranty Registration, ex-factory Serial Number, etc. Note that all labels shall be kept intact. The warranty is valid only when the information above is correct, genuine, and complete;
3. Make sure the product is properly packed during delivery, the original package is highly recommended.
4. The ePropulsion Service Partners will conduct diagnosis and examination on the defective products to check the validity of the warranty claim.
5. If your warranty claim is accepted, the Product or its defective components/parts will be either repaired or replaced free of charge. Note that any delivery cost incurred in the process shall be bearded by you.
6. In case your warranty claim be rejected, a repair/replace cost and fee with round trip delivery cost will be estimated and sent to you for confirmation. ePropulsion Service Partners will only begin the work after your written confirmation.

WARRANTY CARD || ePropulsion Control System

(*In order to validate warranty, please fill in this form first and read the Warranty Policies.)

|| OWNER INFO. ||

Owner Name			
Address			
Phone		Email	

|| DEALER INFO. ||

Store Name			
Address			
Phone		Email	

|| PRODUCT INFO. ||

Date of Purchase (mm/dd/yyyy)	
Serial No.	

Guangdong ePropulsion Technology Limited

Webseite: www.epropulsion.com

E-Mail: service@epropulsion.com