

PROFESSIONAL WIFI WEATHER STATION

Operation Manual

Model: HP2550

Thank you for purchasing this Professional WIFI Weather Station! This device provides accurate weather readings and is Wi-Fi capable to stream data from the weather station to Internet based weather services.

This manual will guide you, step-by-step, through setting up your weather station and console, and understanding the operation of your weather station. Use this manual to become familiar with your professional weather station and save it for future reference.



1 Table of Contents

1 TABLE OF CONTENTS.....	2
2 WARNINGS AND CAUTIONS.....	5
3 UNPACKING.....	6
4 OVERVIEW.....	7
4.1 DISPLAY CONSOLE.....	7
4.2 INDOOR SENSOR:.....	7
4.3 OUTDOOR SENSOR:.....	8
4.4 OPTIONAL SENSOR.....	8
5.SET UP GUIDE.....	11
5.1 PRE INSTALLATION CHECKOUT.....	11
5.2 SITE SURVEY.....	11
5.3 OUTDOOR SENSOR PACKAGE ASSEMBLY.....	12
5.3.1 <i>Install U-bolts and metal plate</i>	12
5.3.2 <i>Install wind vane</i>	13
5.3.3 <i>Install wind speed cups</i>	13
5.3.4 <i>Install the Rain Gauge Funnel</i>	14
5.3.5 <i>Install Batteries in sensor package</i>	14
5.3.6 <i>Mount assembled outdoor sensor package</i>	15
5.3.7 <i>Reset Button and Transmitter LED</i>	16
5.4 INDOOR SENSOR SET UP.....	17
5.5 MULTI-CHANNEL TEMPERATURE AND HUMIDITY SENSOR (OPTIONAL).....	18
5.5.1 <i>Install batteries</i>	18
5.5.2 <i>Sensor Placement</i>	20
5.6 BEST PRACTICES FOR WIRELESS COMMUNICATION.....	21
5.7 CONSOLE DISPLAY.....	22
5.7.1 <i>Initial Display Console Set Up</i>	24
5.7.2 <i>Key functions</i>	25
5.7.3 <i>Main interface icons explain</i>	26
5.8 MULTIPLE CHANNEL SELECTION AND SCROLL MODE.....	28

5.9 HISTORY MODE.....	28
5.9.1 View and Reset MAX/MIN.....	28
5.9.2 History Record Mode.....	30
5.9.3 View Graph.....	32
5.9.4 View Channel Data.....	33
5.10 SETTING MODE.....	34
5.10.1 Date and Time setting.....	36
5.10.2 Time Format setting.....	37
5.10.3 Date Format setting.....	38
5.10.4 Temperature unit setting.....	38
5.10.5 Barometric unit.....	38
5.10.6 Wind speed unit.....	38
5.10.7 Rainfall unit.....	38
5.10.8 Solar Rad. Unit.....	38
5.10.9 Multi Channel Sensor.....	38
5.10.10 Backlight setting.....	40
5.10.11 Longitude: Latitude setting.....	41
5.10.12 Barometric display.....	42
5.10.13 Rainfall season (default: January).....	42
5.10.14 Storing Interval (1-240minutes Selectable).....	43
5.10.15 Weather Server.....	43
5.10.15.1 Wunderground server setup.....	44
5.10.15.2 Weathercloud server setup.....	51
5.10.16 Wi-Fi scan.....	61
5.10.17 Background.....	63
5.10.18 More.....	63
5.11 ALARM SETTING MODE.....	69
5.12 CALIBRATION MODE.....	70
5.13 FACTORY RESET.....	75
5.13.1 Re-register indoor transmitter.....	75
5.13.2 Re-register outdoor transmitter.....	75
5.13.3 Automatic Clear Max/Min.....	76
5.13.4 Reset to Factory.....	76

5.13.5 Clear History.....	76
5.13.6 Clear Max/Min.....	76
5.13.7 Backup data.....	77
5.13.8 About information.....	77
5.13.9 Language.....	78
6. OTHER CONSOLE FUNCTIONS.....	78
6.1BEAUFORT WIND FORCE SCALE.....	78
6.2WEATHER FORECASTING.....	79
6.3 LIGHTNING ALERT.....	79
6.4 WEATHER FORECASTING DESCRIPTION AND LIMITATIONS.....	79
6.5MOON PHASE.....	80
7. MAINTENANCE.....	82
8. TROUBLESHOOTING GUIDE.....	83
9. GLOSSARY OF COMMON TERMS.....	87
10. SPECIFICATIONS.....	90

2 Warnings and Cautions

 **Warning:** Any metal object may attract a lightning strike, including your weather station mounting pole. Never install the weather station in a storm.

 **Warning:** If you are mounting the weather station to a house or structure, consult a licensed electrician for proper grounding. A direct lightning strike to a metal pole can damage or destroy your home.

 **Warning:** Installing your weather station in a high location may result in injury or death. Perform as much of the initial check out and operation on the ground and inside a building or home. Only install the weather station on a clear, dry, day.

3 Unpacking

Open your weather station box and inspect that the contents are intact (nothing broken) and complete (nothing missing). Inside you should find the following:

QT	Item Description
1	Display Console
1	Outdoor Sensor Body with built-in: Thermo-hygrometer / Rain Gauge / Wind Speed Sensor/ Wind Direction Sensor, Light and UV sensor, Solar panel
1	Wind speed cups (to be attached to outdoor sensor body)
1	Wind vane (to be attached to outdoor sensor body)
1	Indoor sensor unit
2	U-Bolts for mounting on a pole
4	Threaded nuts for U-Bolts (M5 size)
1	Metal mounting plate to be used with U-Bolts
1	Wrench for M5 bolts
1	AC adapter
1	User manual (this manual)

Table: Package content

If components are missing from the package, or broken, please contact customer service to resolve the issue.

Note: Batteries for the outdoor sensor package are **not included**. You will need 2 AA size batteries, alkaline or Lithium batteries (Lithium recommended for colder climates).

Note: The console operates using an AC adapter. The included adapter is a switching-type adapter and can generate a small amount of electrical interference with the RF reception in the console, when placed too close to the console. Please keep the console display at least 2 ft. or 0.5 m away from the power adapter to ensure best RF reception from the outdoor sensor package.

4 Overview

4.1 Display console

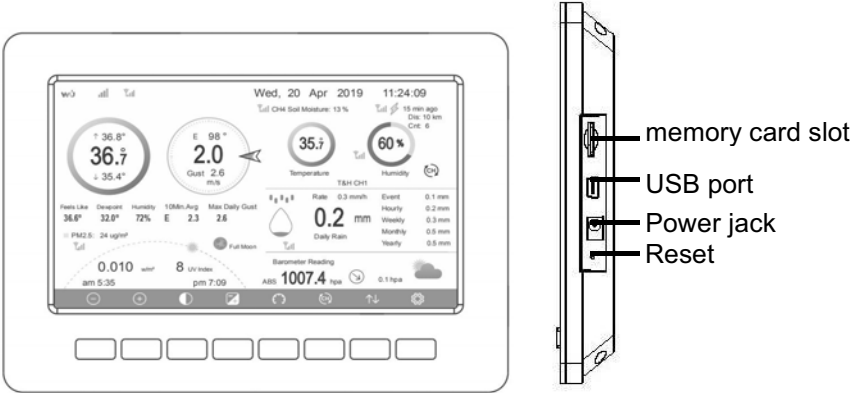

Figure 1: Display console

Note: The USB port in the console of weather station is only for firmware update, not for data communication (USB cable not included). You can use a SD card for the firmware update.(SD card not included).

4.2 Indoor sensor:

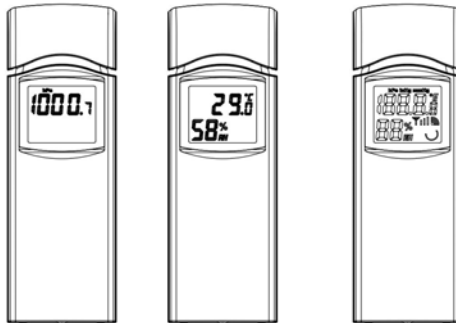

Figure 2: Indoor sensor 2 display variations

The indoor sensor will display indoor temperature, humidity and barometric pressure alternately.

4.3 Outdoor sensor:

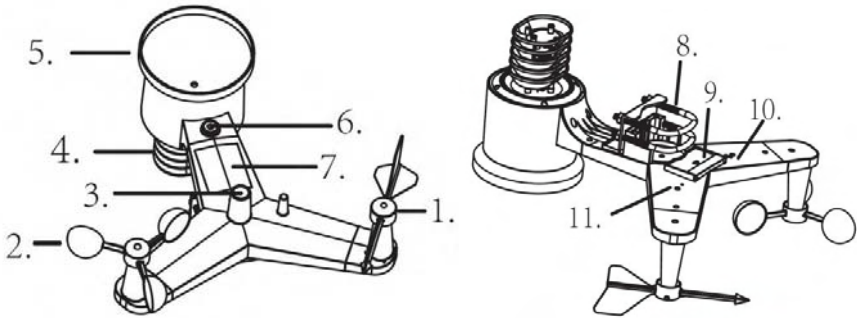

Figure 3: Sensor assembly components

1 Wind vane	7 Solar panel
2 Wind speed cups	8 U-Bolts
3 Light sensor and UV sensor	9 Battery compartment door
4 Thermo- and hygro-meter sensor	10 Reset button
5 Rain collector	11 LED (red) to indicate data transmission
6 Bubble level	







Table: Sensor assembly detailed items

4.4 Optional sensor

The following optional sensors (purchased separately) can be used with HP2550 console display.

If you have purchase extra sensors, just simple power up, the display console will receives the data automatically. If sensor not reporting in to console, the display console will re-search the data after one hour or restart the console to search the data. Please refer to the sensor manual (provided separately with sensor) for details.

This table shows the maximum number of each type of sensor that can be worked with console display

Sensor	Image	Maximum Number
WH31 Multi-channel temperature and humidity sensor		8
WH51 Soil moisture sensor		8
WH41 outdoor PM2.5 air quality sensor WH43 indoor PM2.5 air quality sensor WH41 and WH43 share the four channels		4
WH55 Water leak alarm		4
WH57 Thunder and lightning		1
WH45 Indoor PM2.5/PM10 CO2 air quality sensor		1
WN34S stainless-steel probe thermometer for soil and water WN34L wire probe thermometer for water WN34S and WN34L share the 8 channels		8

Note: For above optional sensors

1. Console display just show the current data, the history data save in the SD card.
2. WU website doesn't support. Ecowitt.net can support these sensor data upload.

5.Set up Guide

5.1 Pre Installation Checkout

To complete assembly you will need a Philips screwdriver (size PH0) and a wrench (size M5; included in package).

Before installing the weather station on the place of operation, we recommend placing the weather station at a temporary location with easy access for one week. This will let you check all functions, ensure proper operation, and get familiar with the weather station and its calibration procedures. During this time, you can also test the wireless range between the main unit and the integrated wireless sensor.

Attention:

- Follow suggested order for battery installation (outdoor sensor first, console second)
- Ensure batteries are installed with correct polarity (+/-)
- Do not mix old and new batteries
- Do not use rechargeable batteries
- If outdoor temperature may go below 32F or 0C for prolonged periods, Lithium based batteries are suggested over alkaline type batteries for the outdoor sensor array

5.2 Site Survey

Perform a site survey before installing the weather station. Consider the following:

1. Avoid radiant heat transfer from buildings and structures. In general, install the sensor array at least 5' or 1.52m from any building, structure, ground, or roof top.
2. Avoid wind and rain obstructions. The rule of thumb is to install the sensor array at least four times the distance of the height of the

tallest obstruction. For example, if the building is 20' or 6.10m tall and the mounting pole is 6' or 1.83m tall, install the sensor array 4 x (20 – 6)' = 56' or 4 x (6.1-1.83)=17.08m away.

3. Installing the weather station over sprinkler systems or other unnatural vegetation may affect temperature and humidity readings. We suggest mounting the sensor array over natural vegetation.
4. Radio Interference. Computers, radios, televisions and other sources can interfere with radio communications between the sensor array and console. Please take this into consideration when choosing console or mounting locations. Make sure your display console is at least five feet or 1.52 meter away from any electronic device to avoid interference.

5.3 Outdoor Sensor Package Assembly

5.3.1 Install U-bolts and metal plate

Slide the U-bolts into the metal plate on the underside of the integrated wireless sensor and screw the nuts from the other side so that the bar on which the integrated wireless sensor is placed can be inserted into this hole.

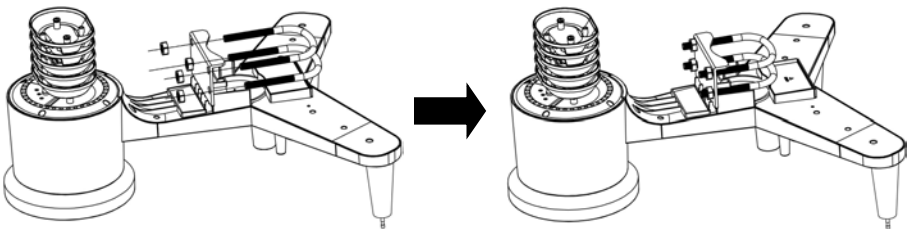

Figure 4: U-Bolt installation

The plate and U-Bolts are not yet needed at this stage but doing this now may help avoid damaging wind vane and wind speed cups later on. Handling of the sensor package with wind vane and speed cups installed to install these bolts is more difficult and more likely to lead to damage.

5.3.2 Install wind vane

Push the wind vane onto the shaft on the top side of the sensor package, until it goes no further, tighten the set screw, with a Philips screwdriver (size PH0). Make sure the wind vane can rotate freely. The wind vane's movement has a small amount of friction, which is helpful in providing steady wind direction measurements.

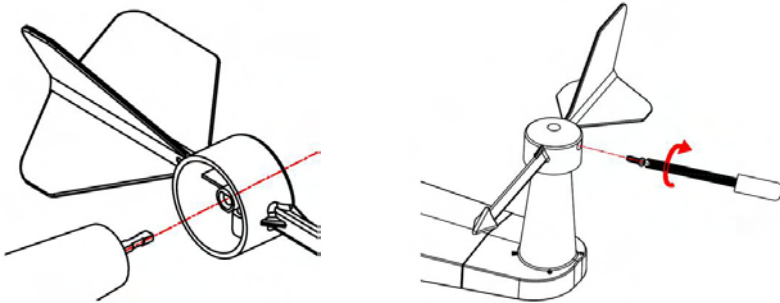

Figure 5: Wind vane installation diagram

The wind direction section on the main unit display shows the letters N (North), E (East), S (South) and W (West). The integrated wireless sensor must be oriented so that the arrow marked “North” on the top of the wireless sensor is pointing north. If the integrated wireless sensor is oriented incorrectly, wind direction measurement will be inaccurate.

5.3.3 Install wind speed cups

Push the wind speed cup assembly onto the shaft on the top side of the sensor package, Tighten the set screw, with a Philips screwdriver (size PH0). Make sure the cup assembly can rotate freely. There should be no noticeable friction when it is turning.

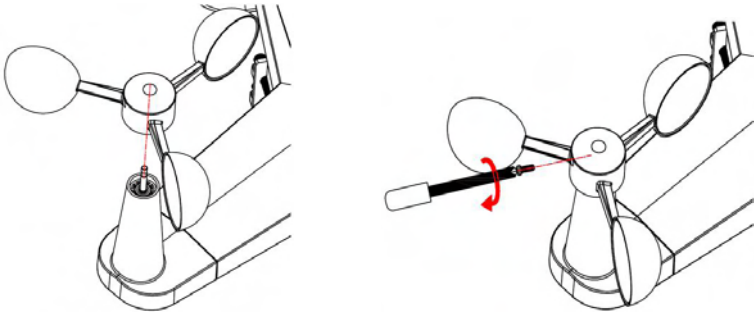

Figure 6: Wind speed cup installation diagram

5.3.4 Install the Rain Gauge Funnel

Rotate clockwise to attach the funnel to the sensor array.

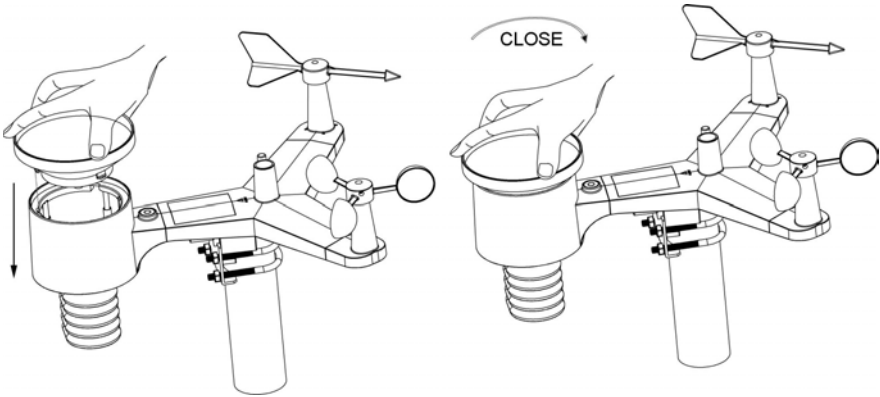

Figure 7: Rain Gauge Funnel installation diagram

5.3.5 Install Batteries in sensor package

Open the battery compartment and insert 2 AA batteries in the battery compartment. The LED indicator on the back of the sensor package will turn on for 4 seconds and then flash once every 16 seconds indicating sensor data transmission.

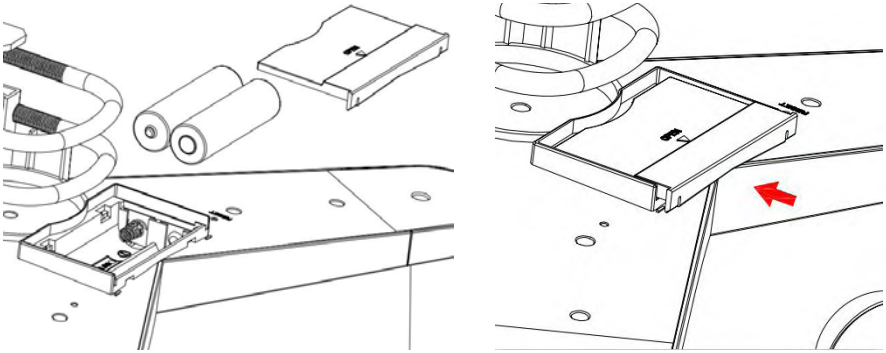

Figure 8: Battery installation diagram

Note: If LED does not light up or is on permanently, make sure the battery is inserted the correct way and inserted fully, starting over if necessary. Do not install the batteries backwards as it may permanently damage the outdoor sensor.

Note: We recommend Lithium batteries for cold weather climates, but alkaline batteries are sufficient for most climates. Rechargeable batteries have lower voltages and should never be used.

5.3.6 Mount assembled outdoor sensor package

Install the integrated wireless sensor in an open space, away from obstacles such as other buildings, trees, etc. that prevent free wind flow, to ensure undistorted measurements of individual weather elements. Point the part with the vane and propeller north for correct wind direction measurement. Place the integrated wireless sensor onto the stand (not included) at a minimum distance of 1.5 metres from the ground to prevent the measured values being affected by the ground surface and tighten the bolts. Use the spirit level on the top of the integrated wireless sensor to ensure that it is level. Tighten the U-bolt nuts.

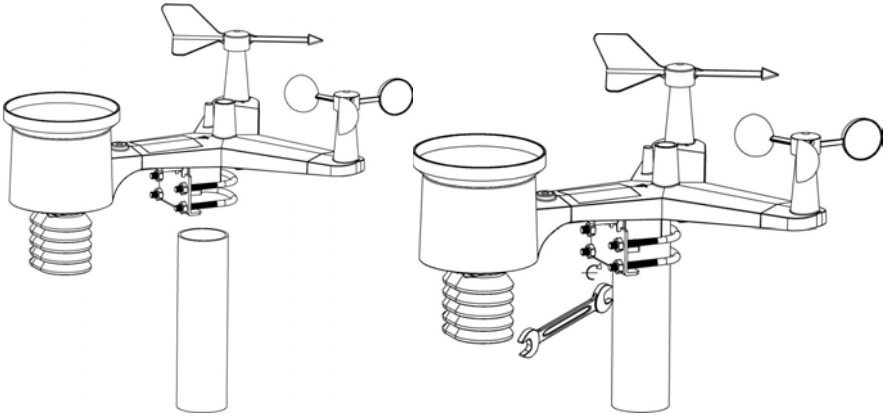

Figure 9: Sensor package mounting diagram

.Note: If you tested the full assembly indoors and then came back here for instructions and mounted to sensor package outdoor you may want to make some further adjustments on the console. The transportation from indoor to outdoor and handling of the sensor is likely to have “tripped” the rainfall sensing bucket one or more times and consequently the console may have registered rainfall that did not really exist. You can use console functions to clear this from history. Doing so is also important to avoid false registration of these readings with weather services..

5.3.7 Reset Button and Transmitter LED

In the event the sensor array is not transmitting, reset the sensor array.

Using a bent-open paperclip, press and hold the **RESET BUTTON** (see Figure 10) to affect a reset: the LED turns on while the RESET button is depressed, and you can now let go. The LED should then resume as normal, flashing approximately once every 16 seconds.

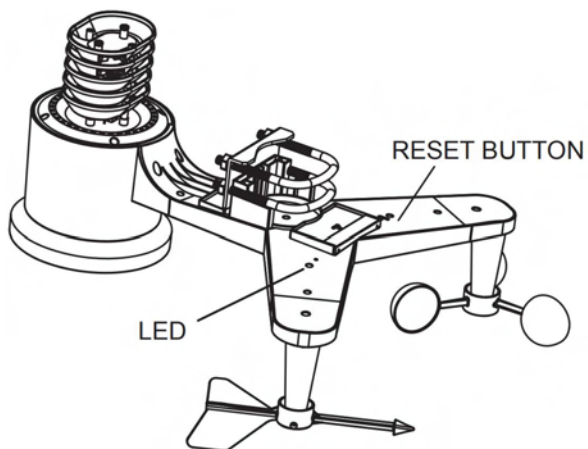

Figure 10: Reset button and Transmitter LED location

5.4 Indoor Sensor Set Up

Note: To avoid permanent damage, please take note of the battery polarity before inserting the batteries.

Remove the battery door on the back of the sensor. Insert two AA batteries.

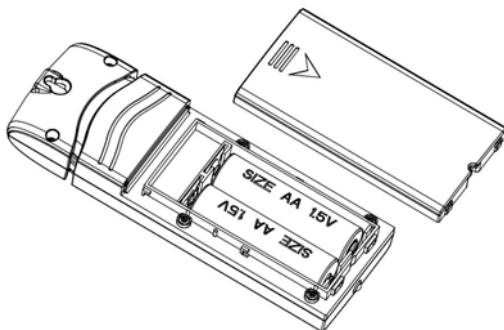

Figure 11: Indoor sensor battery installation

5.5 Multi-channel temperature and humidity sensor (Optional)

The HP2550 supports up to 8 additional thermo-hygrometer sensors (WH31), which can be viewed on the display tablet and Internet.

Note: Do not use rechargeable batteries. We recommend fresh alkaline batteries for outdoor temperature ranges between -10 °C and 60 °C and fresh lithium batteries for outdoor temperature ranges between -40 °C and -10 °C.

5.5.1 Install batteries

1. Remove the battery door on the back of the transmitter(s) by sliding down the battery door, as shown in Figure 12 .

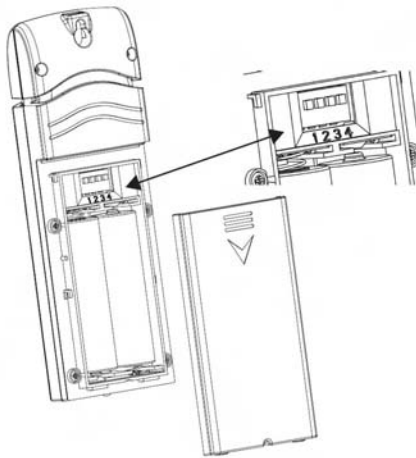
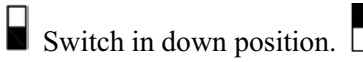
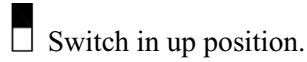

Figure 12: Battery installation for Multi-channel sensor

2. **BEFORE** inserting the batteries, locate the dip switches on the inside cover of the lid of the transmitter.
3. **Channel Number:** The device supports up to eight sensors. To set each channel number change Dip Switches 1, 2 and 3, as referenced in Figure 13 .
4. **Temperature Units of Measure:** To change the transmitter display units of measure (°F vs. °C), change Dip Switch 4, as referenced in

Figure 13.

 Switch in down position.  Switch in up position.

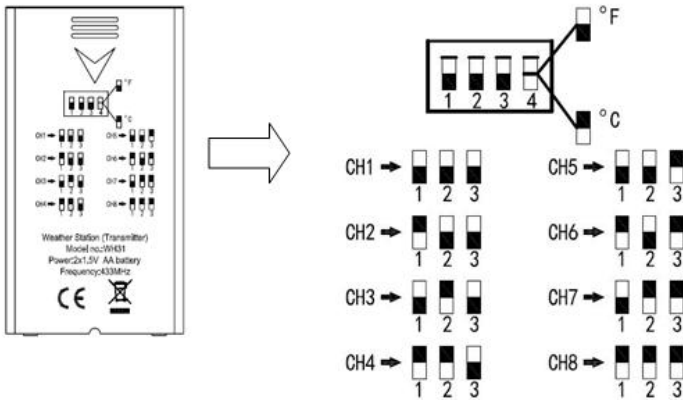
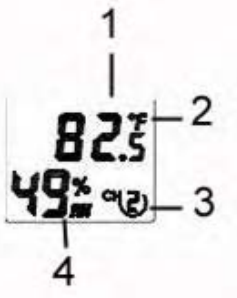

Figure 13: Dip Switch diagram

5. Insert two AA batteries.
6. Verify the correct channel number (CH) and temperature units of measure (°F vs. °C) are on the display, as shown in Figure 14.



- (1) Temperature
- (2) Temperature units (°F vs. °C)
- (3) Channel number
- (4) Relative humidity

Figure 14: sensor LCD display

7. Close the battery door.

Repeat for the additional remote transmitters, verifying each remote is on a different channel.

5.5.2 Sensor Placement

The best mounting location for the indoor sensor is in a location that never receives direct sunlight, not even through windows. Also, do not install in a location where a nearby radiant heat source (radiator, heaters, etc.) will affect it. Direct sunlight and radiant heat sources will result in inaccurate temperature readings.

The sensor is meant to provide indoor conditions for display on the console, but if you would rather have a second source for outdoor conditions instead, you can mount this unit outside. Recommend to mount the unit under cover (eave or awning or similar).

To mount or hang the unit on a wall or wood beam:

- Use a screw or nail to affix the remote sensor to the wall, as shown on the left side of Figure 15, or
- Hang the remote sensor using a string, as shown in right side of Figure 15

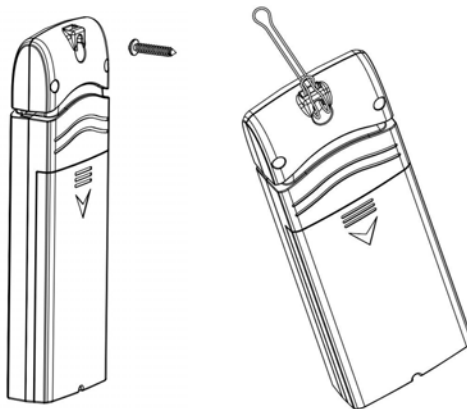

Figure 15: Indoor sensor mounting

Note: Make sure the sensor is mounted vertically and not lying down on a flat surface. This will insure optimum reception.

5.6 Best Practices for Wireless Communication

Wireless (RF) communication is susceptible to interference, distance, walls and metal barriers. We recommend the following best practices for trouble free wireless communication between both sensor packages and the console:

- **Indoor sensor placement:** The sensor will have the longest reach for its signal when mounted or hung vertically. Avoid laying it down on a flat surface.
- **Electro-Magnetic Interference (EMI).** Keep the console several feet away from computer monitors and TVs.
- **Radio Frequency Interference (RFI).** If you have other devices operating on the same frequency band as your indoor and/or outdoor sensors and experience intermittent communication between sensor package and console, try turning off these other devices for troubleshooting purposes. You may need to relocate the transmitters or receivers to avoid the interference and establish reliable communication. The frequencies used by the sensors are one of (depending on your location): 433, 868, or 915 MHz (915 MHz for United States).
- **Line of Sight Rating.** This device is rated at 300 feet line of sight (under ideal circumstances; no interference, barriers or walls), but in most real-world scenarios, including a wall or two, you will be able to go about 100 feet.
- **Metal Barriers.** Radio frequency will not pass through metal barriers such as aluminum siding or metal wall framing. If you have such metal barriers and experience communication problems, you must change the placement of sensor package and or console.

The following table shows different transmission media and expected signal strength reductions. Each “wall” or obstruction decreases the transmission range by the factor shown below.

Medium	RF Signal Strength Reduction
Glass (untreated)	5-15%
Plastics	10-15%
Wood	10-40%
Brick	10-40%
Concrete	40-80%
Metal	90-100%

Table: RF Signal Strength reduction

5.7 Console Display

See 6 to help you identify elements of the console’s display screen.

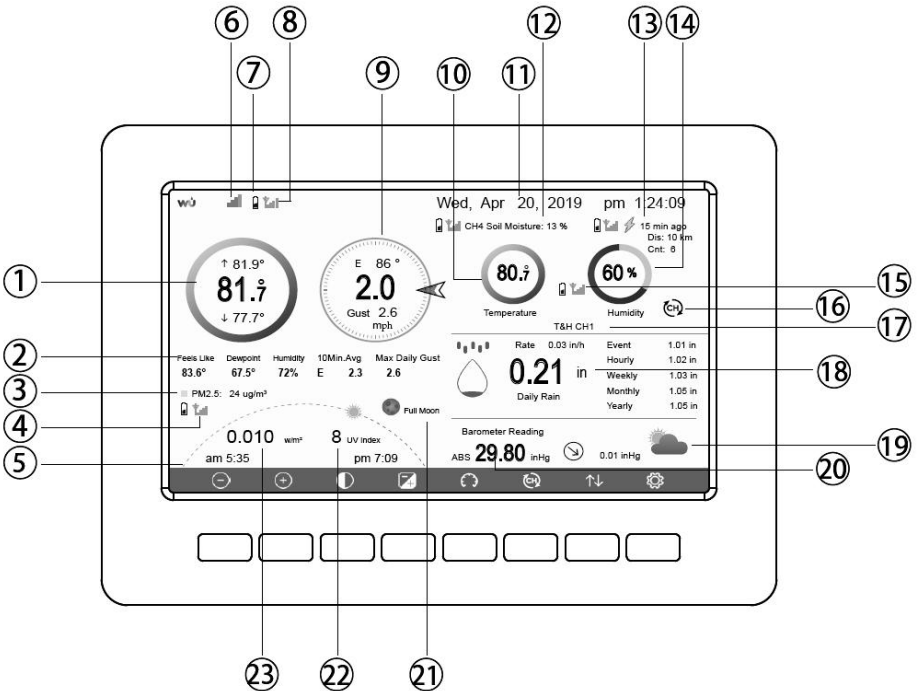

Figure 16: Display Console Screen Layout

No	Description	No	Description
1	Outdoor temperature	13	Last lightning strikes detected time / distance; daily counts (optional sensor)
2	Outdoor Feels Like/Dew point/Humidity/10Min. Average Wind Direction/Max Daily Gust	14	Indoor humidity
3	PM2.5 concentration(optional sensor)	15	RF signal bar for multi-channel temperature and humidity sensor(optional sensor)
4	RF signal bar for PM2.5 sensor(optional sensor)	16	Multi-channel temperature and humidity sensor cycle display mode icon(optional sensor)
5	Sunrise / Sunset Time	17	Multi-channel temperature and humidity sensor channel number (optional sensor)
6	Wi-Fi signal bar	18	Rain fall Daily/Event/Hourly/Weekly/ Monthly/Yearly
7	Low battery power indicator for each sensor	19	Weather forecast
8	RF signal bar for outdoor sensor array	20	ABS/REL Barometer
9	Wind direction/Wind speed/Gust	21	Moon Phase
10	Indoor temperature	22	UV
11	Date and time	23	Solar Radiation
12	Soil moisture(optional sensor)		

Table: Display console detailed items

5.7.1 Initial Display Console Set Up

Immediately after power up (inserting power adapter), the unit will turn on the display, and the unit will start to look for reception of the indoor and outdoor sensor data. This may take up to 3 minutes.

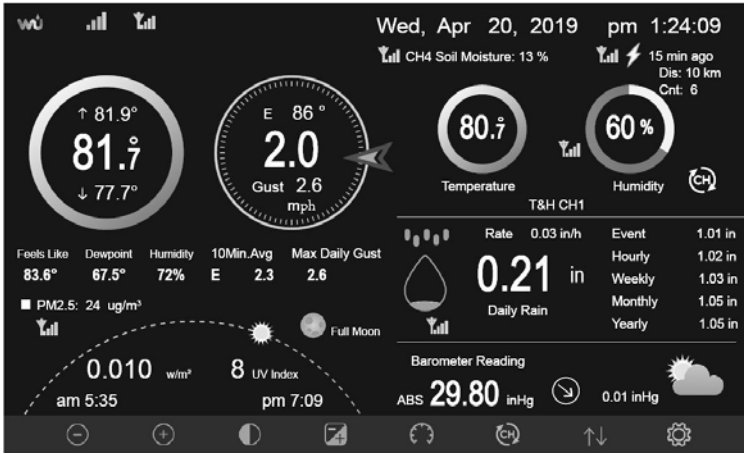

Dark Background Display



Light Background Display

Note: Sunrise/sunset time display will only work properly when GEO location has been set up correctly. GEO setup can be carried out under setup menu.

5.7.2 Key functions

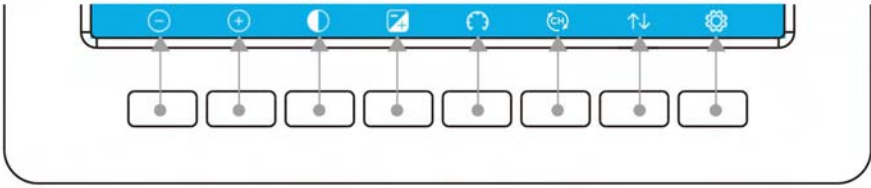

Figure 17: Buttons around the display

There is a set of eight keys on the bottom of the display console. The following table briefly explains the function of these keys.























Icon	Description
	Brightness control key Press this key to decrease the brightness
	Brightness control key Press this key to enhance the brightness
	Backlight on/off key Press this key to on/off the backlight
	Background key Press this key to choose between dark background display and light background display
	Pressure display key Press this key to choose the display between Absolute pressure and Relative pressure.
	Channel key Press this key to Shift the display between indoor temp & humidity, Multiple Channel temp& humidity and scroll automatically mode
	History key Press this key once to view Max/Min record and twice to enter History mode.
	Setting key Press this key to enter Setting Mode



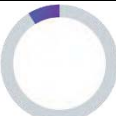









Table: Console buttons

5.7.3 Main interface icons explain

5.7.3.1 Temperature Icon

Temperature Range (degF)	Color Ring	Temperature Range (degF)	Color Ring
< -10		50-60	
-10 to 0		60-70	
0 to 10		70-80	
10-20		80-90	
20-30		90-100	
30-40		100-110	
40-50		> 110	









5.7.3.2 Humidity Icon

Humidity Range (%)	Color Ring	Humidity Range (%)	Color Ring
0%, No signal or dashes		50 to 60	
1 to 10		60 to 70	
10 to 20		70 to 80	
20 to 30		80 to 90	
30 to 40		90 to 99	
40 to 50		100%	

5.7.3.3 Current wind direction indication , 10-minute average wind

direction indication .

5.7.3.4 Hourly Rainfall Icon

Hourly Rain (in)	Icon	Hourly Rain (in)	Color Ring
0.0		0.6 to 0.8	
0 to 0.2		0.8 to 1	
0.2 to 0.4		1 to 1.2	
0.4 to 0.6		1.2 to 1.4	

5.8 Multiple Channel Selection and Scroll Mode

Multi-channel sensor is an optional sensor, not included in the package. If

you have multiple wireless sensors, while in normal mode, press the  key to toggle display in sequence of indoor, ch1, ch2....ch8, scroll display. Please note if only CH2 is received, it will skip CH1, and toggle only between indoor and already learned sensors.

While in Scroll display mode, the scroll icon  will be displayed next to the indoor humidity, and will scroll every 5 seconds.

Note: For multi channel sensor, only the current data of each sensor can be viewed on the console, and no history data will be saved or uploaded to any weather servers.

5.9 History Mode

5.9.1 View and Reset MAX/MIN

While in normal display, press the  key once to view and reset minimum and maximums.

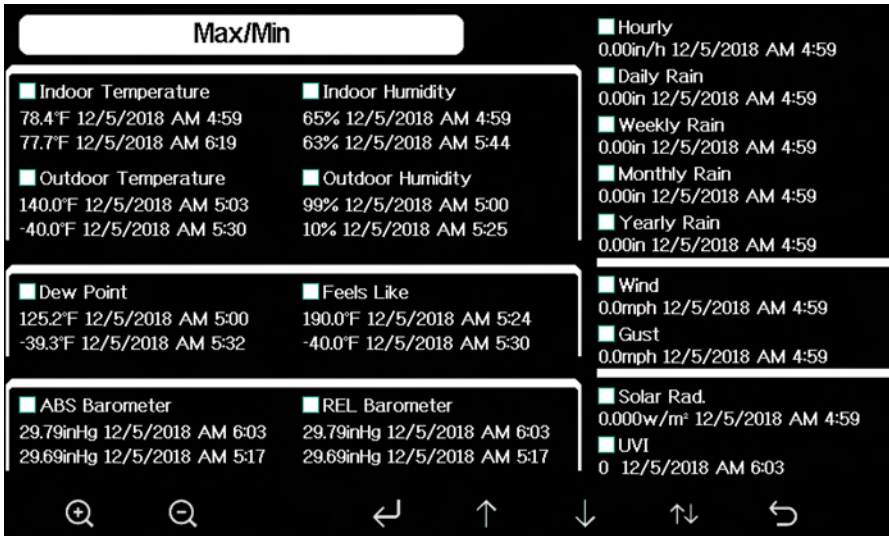





Figure 18: Max/Min Screen

Icon	Description
	Selection key Press this key to select the weather MAX/MIN record which need to clear
	Selection key Press this key to select the weather MAX/MIN record which need to clear
	Enter key While the desired weather MAX/MIN record selected , press this key to popup Message Box "Clear the Max/Min record?". Press key or key to select YES or NO. Press the key or key to confirm the selection.
	Up arrow key Press this key to change the activated option field
	Down arrow key Press this key to change the activated option field





	History key Press this key to select History data display.
	Return key Press this key to return to normal display mode



5.9.2 History Record Mode

While in normal display, press the  key twice to enter History Record Mode.



No	Time	Indoor Temperature (F)	Indoor Humidity (%)	Outdoor Temperature (F)	Outdoor Humidity (%)	Dew Point (F)	Feels Like (F)	Wind (mph)
2689	12/5/2018 AM 6:40	77.7	65	68.9	47	47.8	68.9	25
2690	12/5/2018 AM 6:45	77.7	65	68.9	47	47.8	68.9	25
2691	12/5/2018 AM 6:50	77.7	65	68.9	47	47.8	68.9	22
2692	12/5/2018 AM 2:40	77.9	65	68.9	47	47.8	68.9	25
2693	12/5/2018 AM 2:45	77.9	65	68.9	47	47.8	68.9	22
2694	12/5/2018 AM 2:50	77.9	65	68.9	47	47.8	68.9	22
2695	12/5/2018 AM 2:55	77.9	65	68.9	46	47.3	68.9	22
2696	12/5/2018 AM 3:00	77.9	65	68.9	46	47.3	68.9	22
2697	12/5/2018 AM 3:05	77.9	65	68.9	46	47.3	68.9	22
2698	12/5/2018 AM 3:10	77.9	65	68.9	46	47.3	68.9	22
2699	12/5/2018 AM 3:15	77.9	65	68.9	46	47.3	68.9	27
2700	12/5/2018 AM 3:20	77.9	64	68.9	46	47.3	68.9	25
2701	12/5/2018 AM 3:25	77.9	65	68.9	46	47.3	68.9	22
2702	12/5/2018 AM 3:30	78.1	65	68.9	46	47.3	68.9	22
2703	12/5/2018 AM 3:35	78.6	65	68.9	46	47.3	68.9	22
2704	12/5/2018 AM 3:40	78.6	65	68.9	46	47.3	68.9	22

Figure 19: History record Screen

Icon	Description
	File Select key Press this key to clear all history record
	Page Select key Press this key to enter particular page of the history data. Each page contains 16sets data.
	Scroll left key Press this key to view the left of the scrollable area.
	Scroll right key Press this key to view the right of the scrollable area.
	Page up key Press this key to scroll up the page you are viewing

	<p>Page down key Press this key to scroll down the page you are viewing</p>
	<p>History key Press this key to select the Max/Min record or History.</p>
	<p>Return key Press this key to return to previous mode</p>

5.9.2.1 Clear the history record

While in History Record Mode, press  key to popup the Message Box: “Clear the history record?” Press “Yes” to clear all history records saved on console. Press  or  key to return to History record Mode.

No	Time	Indoor Temperature (°F)	Indoor Humidity (%)	Outdoor Temperature (°F)	Outdoor Humidity (%)	Dew Point (°F)	Feels Like (°F)	Wind (mph)
2721	12/5/2018 AM 5:13	78.4	65	24.8	54	10.4	24.8	0.0
2722	12/5/2018 AM 5:18	78.4	65	59.0	73	50.4	59.0	0.0
2723	12/5/2018 AM 5:23	78.4	65	87.8	89	84.2	111.7	0.0
2724	12/5/2018 AM 5:28				19	69.8	123.8	0.0
2725	12/5/2018 AM 5:33				39	-39.3	-22.0	0.0
2726	12/5/2018 AM 5:38				58	0.1	12.2	0.0
2727	12/5/2018 AM 5:43				74	33.4	41.0	0.0
2728	12/5/2018 AM 5:48				95	77.2	78.8	0.0
2729	12/5/2018 AM 5:52				24	67.6	113.0	0.0
2730	12/5/2018 AM 5:57				42	--	-36.4	0.0



 Clear the history record?

Figure 20: Clear History Record Screen

5.9.2.2 View a specific page of history

While in History Record Mode, press the  key to enter the page selection mode:









No	Time	Indoor Temperature (°F)	Indoor Humidity (%)	Outdoor Temperature (°F)	Outdoor Humidity (%)	Dew Point (°F)	Feels Like (°F)	Wind (mph)
2721	12/5/2018 AM 513	78.4	65	24.8	54	10.4	24.8	0.0
2722	12/5/2018 AM 518	78.4	65	59.0	73	50.4	59.0	0.0
2723	12/5/2018 AM 523	78.4	65	87.8	89	84.2	111.7	0.0
2724	12/5/2018 AM 528	78.4	65	123.8	19	69.8	123.8	0.0
2725	12/5/2018 AM 533				89	-39.3	-22.0	0.0
2726	12/5/2018 AM 538				68	0.1	12.2	0.0
2727	12/5/2018 AM 543				74	33.4	41.0	0.0
2728	12/5/2018 AM 548				95	77.2	78.8	0.0
2729	12/5/2018 AM 552				94	67.6	113.0	0.0
2730	12/5/2018 AM 557				42	--	-36.4	0.0
2731	12/5/2018 AM 624	77.4	64	-4.0	71	-11.2	-4.0	0.0

View data on page 1 to 171

00171

Ok Cancel

Figure 21: view a specific page of history Screen

Press  or  to select a digit in a number, press  or  key to change the number. Press  or  to change the activated option field, toggle OK or Cancel then press  or  key to confirm.

5.9.3 View Graph

While in History Record Mode, press the  key three times to enter Graph Mode.

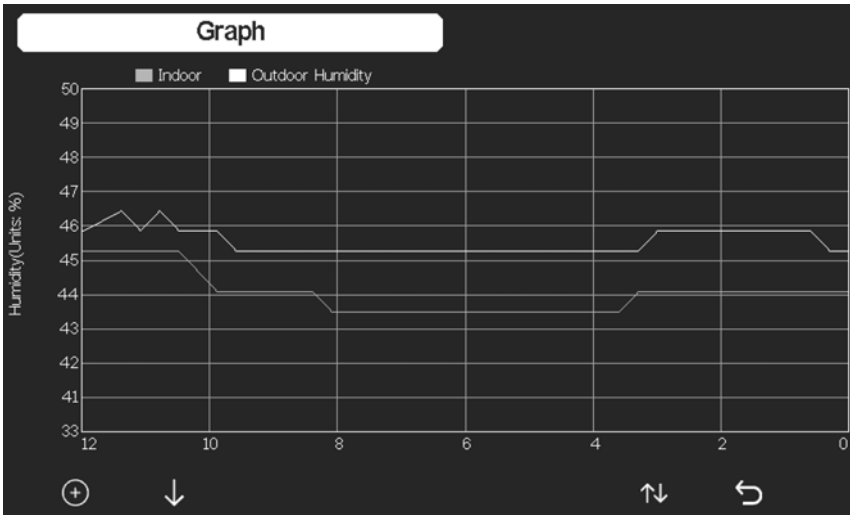





Figure 22: Graph Screen

Press  to shift the data display of 12/24/48/72H. Press  to view the graph of the following data:

- Indoor outdoor temperature
- Dew Point and Feels like
- Indoor outdoor humidity
- Wind speed and Gust
- Wind Direction
- UVI
- Solar radiation
- Rainfall hourly and daily
- Barometer (REL & ABS)

5.9.4 View Channel Data

While in normal display, press the  key four times to enter Channel Data Mode.

If you purchase the optional sensor, soil moisture sensor or PM2.5 sensor or multi-channel temperature and humidity sensor, their data can be showed on Channel Data screen.

Wn45		T&H CH1	T&H CH2	T&H CH3	T&H CH4	T&H CH5	T&H CH6
T&H 93.7°F 61%	CO2 712ppm	79.3°F 68%	80.1°F 66%	79.3°F 66%	80.1°F 68%	80.1°F 68%	80.1°F 68%
PM25 4ug/m³ Good AQI 18 24H 14	PM10 7ug/m³ Good AQI 32 24H 14	T&H CH7 79.5°F 66%	T&H CH8 79.5°F 67%	Soil CH1 0%	Soil CH2 0%	Soil CH3 0%	Soil CH4 84%
Soil CH5 0%	Soil CH6 0%	Soil CH7 0%	Soil CH8 0%	PM25 CH1 12ug/m³ Good AQI 50 24H 33	PM25 CH2 10ug/m³ Good AQI 42 24H 46	PM25 CH3 11ug/m³ Good AQI 46 24H 42	Water CH3 Normal
Thunder -- min ago Dis Cnt -- 0	WN34 CH1 81.9°F						

Figure 23: Channel Data Screen

5.10 Setting Mode













While in normal display, press the  key to enter Setting Mode. You can select the below sub-mode by pressing the  key



Figure 24: Setup Menu Screen

Icon	Description
	Select key Press this key to select the unit or scrolls the value
	Select key Press this key to select the unit or scrolls the value.
	Left key Press this key to select the set value.
	Right key Press this key to select the set value.
	Up arrow key Press this key to change the activated option field
	Down arrow key Press this key to change the activated option field
	Set key Press this key to select the Setting sub-Mode
	Return key Press this key to return to previous mode

5.10.1 Date and Time setting

While in Menu Setting Mode, press  key to select Date and Time Setup field, press  or  key to enter Date and Time Setup mode:

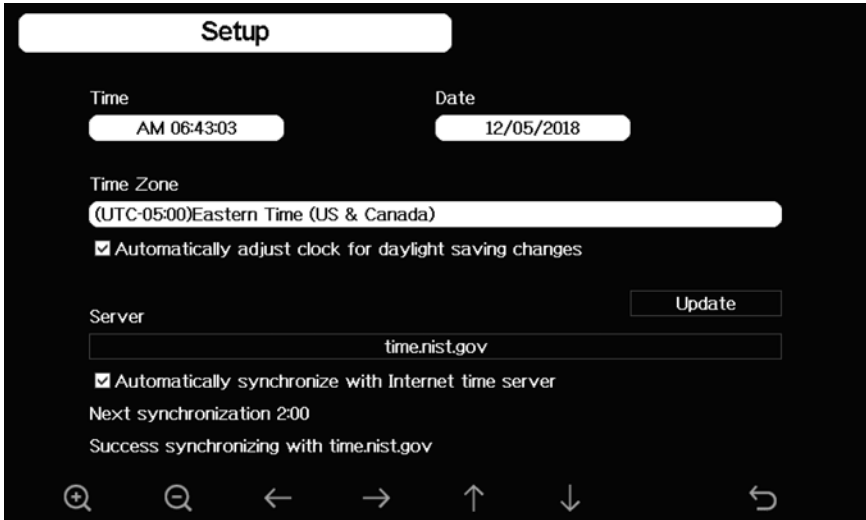



















Figure 25: Time and date Setup Screen







1) Time setting (hour/minute/second)

Press  key to select time setting field, and the hour digit will turn red, press the  or  key to change the hour setting. Press  to set the minute, the minute digit will turn red, press the  or  key to change the minute setting. Press  to set the second, and the second digit will turn red, press the  or  key to change the second setting



2) Date setting

Press  key to select Date setting field, the day digit on focus turns red, press the  or  key to change the day setting. Press  to set the month, then month digit focused will turn red, press the  or  key to change the month setting. Press  to set the year, the year digit on focus will turn red, press the  or  key to change the year setting

3) Time zone setting

Press  key to select Time zone setting field, press the  or  key to change the time zone setting. Press  key to select Update field, press the  or  key to update the time immediately.

4) Automatically synchronize with internet time server

The time server is time.nist.gov. Press the  or  key to tick "Automatically synchronize with internet time server" and press "update" to synchronize with time server immediately. Console time will be updated at 2:01am automatically when internet access is possible.

5.10.2 Time Format setting

Press  to change the time format between hour: minute: second (h:mm:ss), hour: minute: second AM (h:mm:ss AM) and AM hour: minute: second (AM h:mm:ss).

5.10.3 Date Format setting

Press  to change the time format between DD-MM-YYYY, YYYY-MM-DD and MM-DD-YYYY

5.10.4 Temperature unit setting

Press  to change the temperature units of measure between °F and °C.

5.10.5 Barometric unit

Press  to change the temperature units of measure between inHg, mmHg and hpa

5.10.6 Wind speed unit

Press  to change the wind speed units of measure between mph, bft (Beaufort scale), ft/s, m/s, km/h and knot.

5.10.7 Rainfall unit

Press  to change the rainfall units of measure between in and mm

5.10.8 Solar Rad. Unit

Press  to change the solar radiation units of measure between W/m², lux and fc.

5.10.9 Multi Channel Sensor

In Multi channel sensor Setup Screen, you can rename the sensor or register the sensor again while the sensor lost connection to console display.

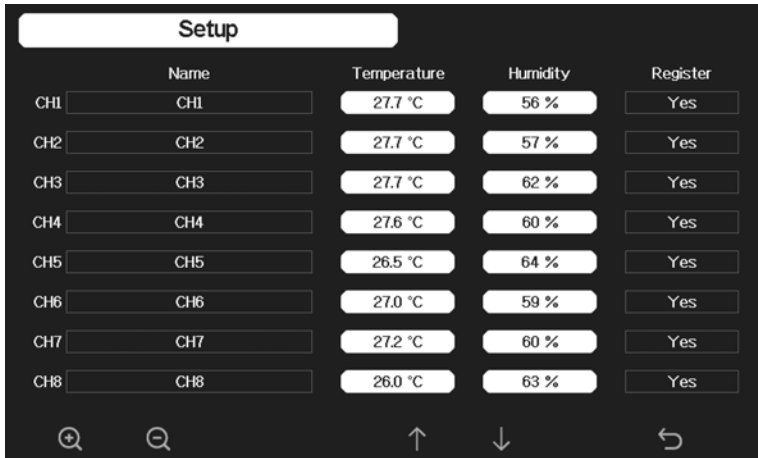











Figure 26: Multi channel sensor Setup Screen

Press  or  key to select Name setting field, the name on focus turns green, press the  or  key to pop up the keyboard to enter the sensor name. Press     to scroll to the character and press  to select the character. Press  to return to the setup page.

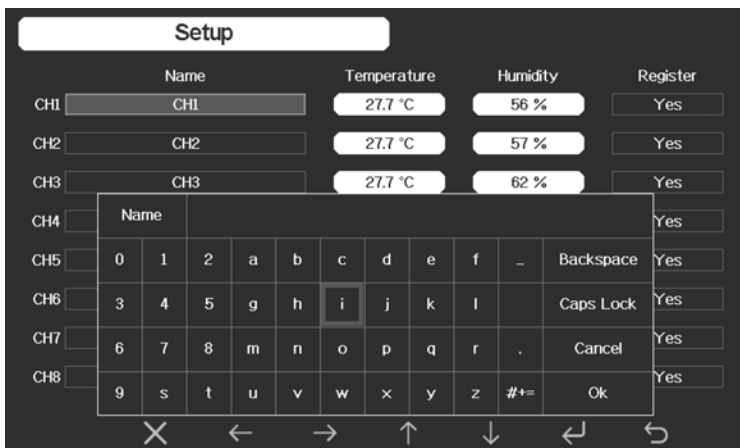









Figure 27: rename the sensor Screen

Press  or  key to select Register setting field, press the  or  key to register the selected sensor

5.10.10 Backlight setting

While in Menu Setting Mode, press  key to select Backlight Setup field, press  or  key to enter backlight Setup mode:

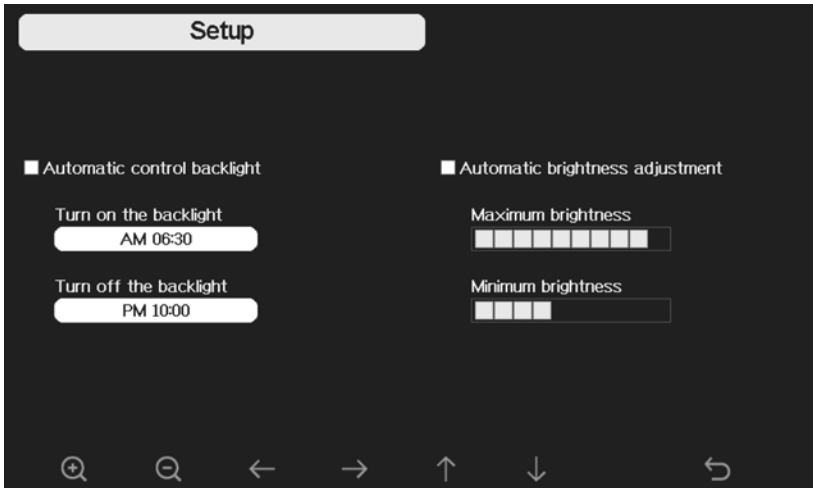

Figure 28: Backlight Setting Screen

Automatic control backlight: select this option, the backlight will auto turn on and off according the set time







Turn on the backlight: set the time of turning on backlight

Turn off the backlight: set the time of turning off backlight

Automatic brightness adjustment: select this option, the brightness will change according to the light intensity measured from outdoor sensor

Maximum brightness: set the maximum brightness while it is the highest light intensity



Minimum brightness: set the minimum brightness while it is the weakest light intensity

Icon	Description
	Select key Press this key to select the unit or scrolls the value
	Select key Press this key to select the unit or scrolls the value.
	Left key Press this key to select the set value.
	Right key Press this key to select the set value.
	Up arrow key Press this key to change the activated option field
	Down arrow key Press this key to change the activated option field
	Return key Press this key to return to previous mode

If the auto backlight turn-on time has been set, you can press  key to turn off the backlight within the turn on time. Backlight will turn on again automatically at next turn on time. You can press any key to turn on the backlight for 60s within the turn off time

5.10.11 Longitude: Latitude setting

While in Menu Setting Mode, press  key to select Longitude: Latitude

Setup field, press  or  key to enter Longitude Latitude Setup mode:

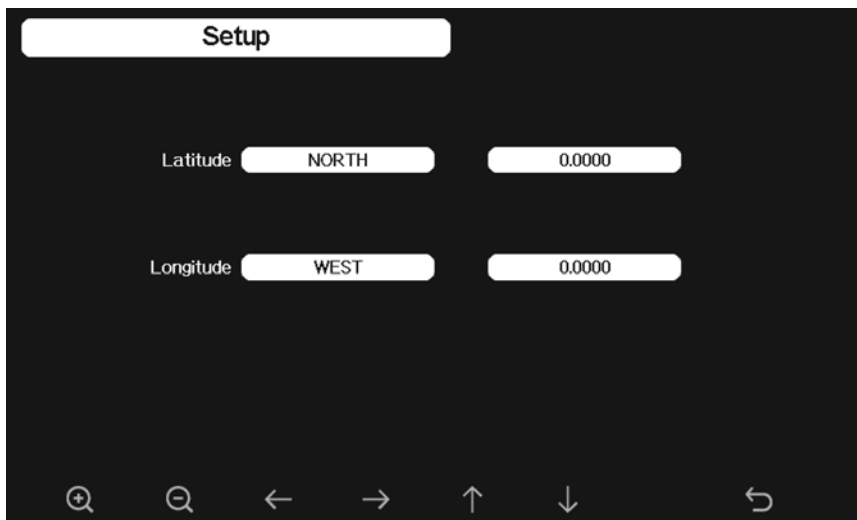



Figure 29: Longitude and Latitude Setting Screen

The sunrise/sunset times will be calculating automatically base on the Longitude and Latitude. Your location GEO info can be found on mobile compass page. Two digits after decimal should be enough for this feature to be working correctly.

5.10.12 Barometric display

Press  to change the barometer display between REL (relative pressure) and ABS (absolute pressure)

5.10.13 Rainfall season (default: January)

Press  to change the beginning of the rainfall yearly season month. The default is January. Rainfall season influence the annual rainfall maximum, minimum and total value. When one month was selected, the annual rainfall and annual max/min rainfall were zero clearing at 0:00 of the first day of the selected month.

5.10.14 Storing Interval (1-240minutes Selectable)

5.10.15 Weather Server

Your console is capable of sending your sensor data to select internet-based weather services. The supported services are shown in the table below:

Service	Website	Description
Ecowitt Weather	https://www.ecowitt.net	Ecowitt is a new weather server that can host a bunch of sensors that other services don't support.
Weather Underground	https://www.wunderground.com	Weather Underground is a free weather hosting service that allows you to send and view your weather station data real-time, view graphs and gauges, import text data for more detailed analysis and use iPhone, iPad and Android applications available at Wunderground.com. Weather Underground is a subsidiary of The Weather Channel and IBM.
WOW	http://wow.metoffice.gov.uk/	WOW is a UK based weather observation website.
Weather Cloud	https://weathercloud.net	Weathercloud is a real-time weather social network formed by observers from around the world.
Customized Website		Supports uploading to your customized website, if the website has the same protocol with Wunderground or Ecowitt

Table: Supported weather services

Note: If you are testing the setup with the outdoor sensor package nearby and indoor, you may want to consider connecting to Wi-Fi, but not yet configuring any of the weather services. The reason is that while indoor the temperatures and humidity recorded by the outdoor sensor, and as reported to the weather service(s) will reflect indoor conditions, and not outdoor conditions. Therefore, they will be incorrect. Furthermore, the rainfall bucket may be tripped during handling, causing rain to register while it may not actually have been raining. One way to prevent this is to follow all instructions, except to use an incorrect password, on purpose! Then, after final outdoor installation, come back and change the password after clearing console history. That will start uploading to the services with a clean slate.

5.10.15 .1 Wunderground server setup

1) Get the station ID and key/password

- ① Visit Wunderground.com and select the **Join** link (1) at the top of the page and select the **Free** (2) sign up option.

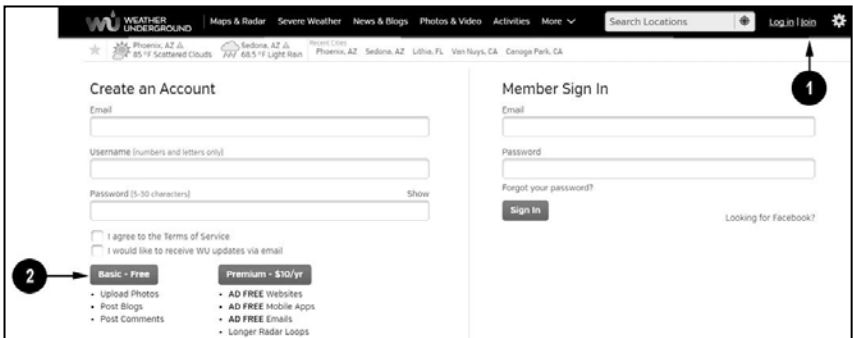

- ② Select **More | Register Your PWS** (3)

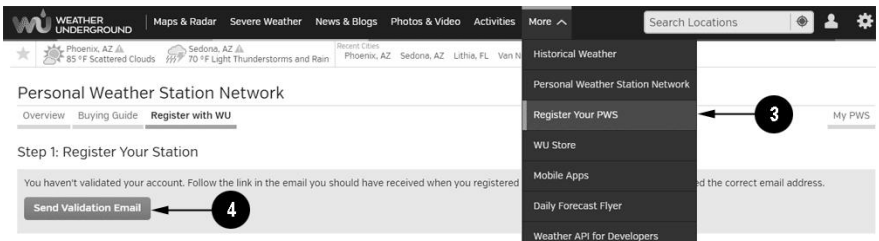

- ③ Click **Send Validation Email** (4). Respond to the validation email from Wunderground.com (it may take a few minutes).
- ④ Select **More | Register Your PWS** (5) again. This time you will be asked details about your weather station. Go ahead and fill out the form

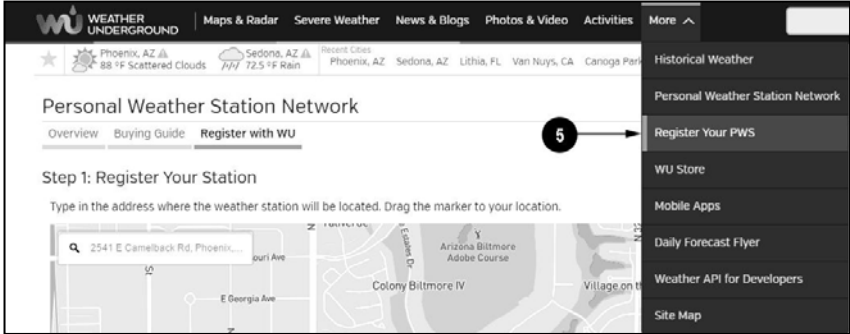

After completing the weather station, you will see something like this:

Congratulations. Your station is now registered with Wunderground!

You are almost done. Now go to your weather station software and add the following:

Your Station ID:
KAZPHOEN424

Your Station Key/Password:
mdreeley

Your station ID will have the form: KSSCCCC###, where K is for USA station (I for international), SS is your state, CCCC is an abbreviation for your city and ### is the station number in that city. In the example above, you see station 424 in the state of Arizona (AZ) in the United States (K).

- ⑤ Take note of the station ID and key/password and enter it in the Weather Server:

2) Registration on console display















Press  or  key to enter Weather Server set up mode. The device can be configured to send real-time data to wunderground.com®. Enter the Station ID and Password obtained from Wunderground.com.











Figure 30: WU Server setup screen

				
scroll value up	scroll value down	Scroll field up	Scroll field down	return to Setup



Set Station ID: Press  to highlight the Station ID. Enter your station ID. Press  to display the keyboard. Press     to scroll to the character and press  to select the character. Press  to return to the setup page.

Set Station Key: Press  to highlight the station key. Enter your password obtained from according weather server. Press  to display the keyboard. Press     to scroll to the character and press  to select the character. Press  to return to the setup page.

3)Viewing data on wunderground.com

The most basic way to observe your weather station’s data is by using the wunderground.com web site. You will use a URL like this one, where your station ID replaces the text “STATIONID”:

<http://www.wunderground.com/personal-weather-station/dashboard?ID=STATIONID>

It will show a page such as this, where you can look at today's data and historical data as well:

Darwin (+9:30 Zone) Test Station IDARWIN13 About this PWS Report Comments

Forecast for Darwin, AU - 12.460 130.841 - 66 ft

PWS Data PWS Widgets WunderStation My PWS

PWS viewed 3 times since July 1, 2018

Satellite Webcam Icon

Current Conditions Station reported 0 second ago

78.4 °F
Feels Like 78.4 °F

12.1 mph Wind from ENE Gusts 12.5 mph

Dew Point: 66.2 °F UV: 0.0 + ...
Humidity: 66% Solar: 0 w/m²
Precip Rate: 0.00 in/hr Soil Moisture: ...
Precip Accum: 0.00 in Soil Temp: ...
Pressure: 29.80 in Leaf Wetness: ...

7:08 AM 6:33 PM
Waning Gibbous | 50% illuminated

View WunderMap

Weather History for Darwin, [IDARWIN13]

Previous Daily Mode Jul 6, 2018 View Next

Summary
July 6, 2018

	High	Low	Average		High	Low	Average
Temperature	82.4 °F	77.4 °F	79.9 °F	Wind Speed	13 mph	--	12 mph
Dew Point	73.8 °F	64.6 °F	70.1 °F	Wind Gust	14 mph	--	--
Humidity	79%	63%	70%	Wind Direction	--	--	West
Precipitation	0 in	--	--	Pressure	29.67 in	29.59 in	--

There are also some very useful mobile apps. The URLs provided here go to the Web version of the application pages. You can also find them directly from the iOS or Google Play stores:

- **WunderStation:** iPad application for viewing your station's data and graphs
<https://itunes.apple.com/us/app/wunderstation-weather-from-your-neighborhood/id906099986>

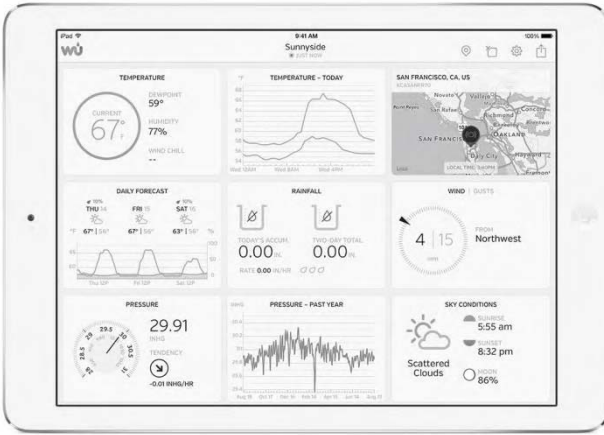

WU Storm: iPad and iPhone application for viewing radar images, animated wind, cloud coverage and detailed forecast, and PWS station data

<https://itunes.apple.com/us/app/wu-storm/id955957721>



Weather Underground: Forecast: iOS and Android application for forecasts

<https://itunes.apple.com/us/app/weather-underground-forecast/id486154808>

<https://play.google.com/store/apps/details?id=com.wunderground.android.weather&hl=en>



- **PWS Weather Station Monitor:** View weather conditions in your neighborhood, or even right in your own backyard. Connects to wunderground.com

<https://itunes.apple.com/us/app/pws-weather-station-monitor/id7137059>

29

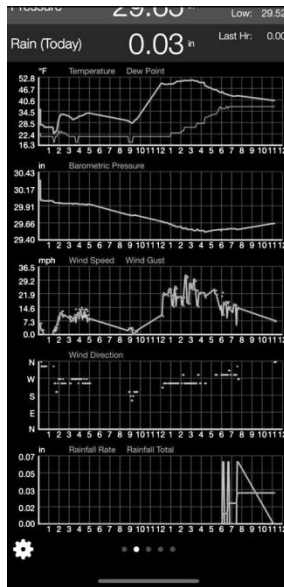

5.10.15.2 Weathercloud server setup

To register with Weathercloud follow these steps:

- 1) Visit weathercloud.net and enter a Username, Email and Password to sign up.



- 2) Respond to the validation email from Weathercloud (it may take a few minutes).



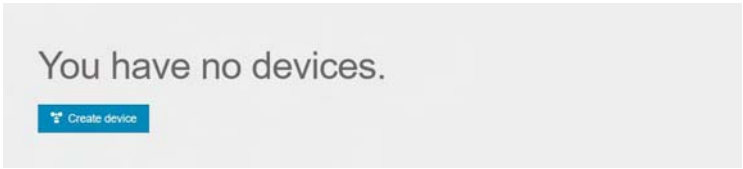

- 3) You will then be prompted to add a device/ Select “Create device” and enter your station’s information:



- 4) After registering your station, take note of the “Weathercloud ID” and “Key” presented to you.
 5) Enter these values in the **Weather Server**:



Figure 31: Weathercloud Server setup screen

				
scroll value up	scroll value down	Scroll field up	Scroll field down	return to Setup

5.10.15.3 Weather Observations Website (WOW) server setup

To have your weather station upload data to the Met Office’s WOW site you will need to complete the following steps:

1) Sign Up with WOW

Navigate your browser to <http://wow.metoffice.gov.uk>. On the top-right side of the resulting page you will see menu options. Click “Sign Up”

You will be presented with the screen below where you will choose to either create a new account or use an already existing account. Click the desired option.

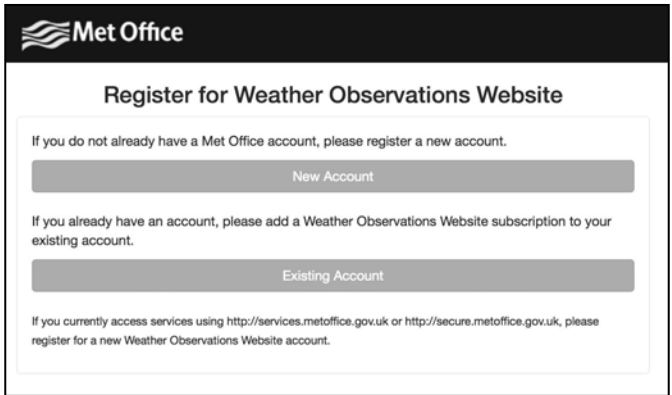

The screenshot shows the Met Office logo at the top left. The main heading is "Register for Weather Observations Website". Below this, there are two options: "New Account" and "Existing Account", each with a corresponding button. A note at the bottom states: "If you currently access services using <http://services.metoffice.gov.uk> or <http://secure.metoffice.gov.uk>, please register for a new Weather Observations Website account."

If you chose “New Account” you will be presented with a form to fill out:

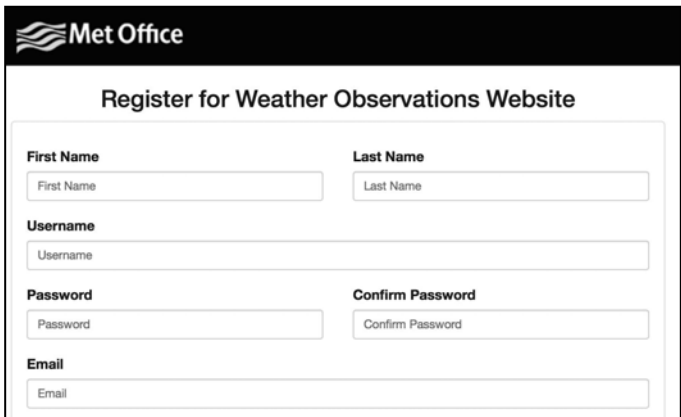

The screenshot shows the Met Office logo at the top left. The main heading is "Register for Weather Observations Website". The form contains the following fields: "First Name" (with a placeholder "First Name"), "Last Name" (with a placeholder "Last Name"), "Username" (with a placeholder "Username"), "Password" (with a placeholder "Password"), "Confirm Password" (with a placeholder "Confirm Password"), and "Email" (with a placeholder "Email").

The actual form is longer, but all questions should be self-explanatory. Complete and submit the form. You will receive the following notice on completion:

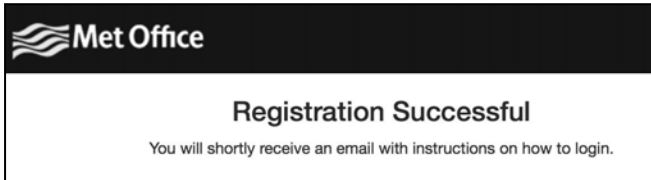

2) Confirm your email with WOW

Respond to the validation email from WOW(it may take a few minutes).

3) Login to WOW

Follow instructions on the screen and login to the site.

4) Create/Set up a new WOW site

Once you are logged in you will need to create a new WOW site. “Sites” are the means by which WOW organizes weather data the you contribute. Basically, WOW builds a personal web site for your weather station. Associated with the web site is two items you will need to allow uploading of data:

Site ID: This is an arbitrary number that is used to distinguish your site from another. This number appears (in brackets) next to or underneath the name of your site on the site information page, for example: 6a571450-df53-e611-9401-0003ff5987fd

Authentication Key: This is a 6-digit number that is used to ensure data is coming from you and not another user.

Begin setting up a new site by clicking “Enter a Site”:

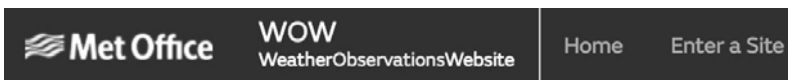

You will be presented with a form where you detail your station's location and a bunch of other settings related to how you wish the site to operate. After you complete the setup, you should see:

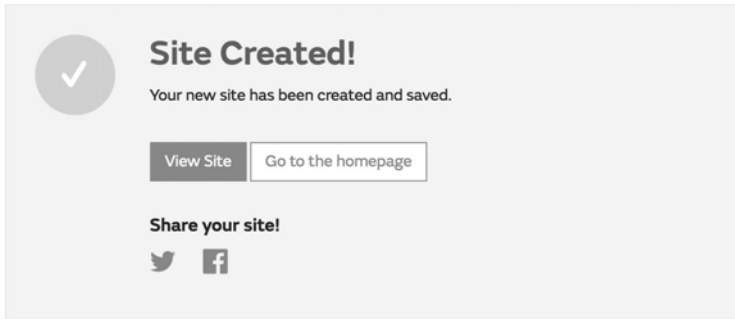

Make sure you are (still) logged in to the WOW site. Login as necessary. Now click on "My Sites" in the navigation bar at the top. If you have only 1 site, you will now be shown its page. If you have multiple, you will have to choose the correct one first. On this page, on the right side you will find the site id just below the map:



You will also need to establish a unique 6 digits PIN code that you should keep secret. It is the "Authentication Key." Setup this number by clicking on "Edit Site") and filling out the with a 6-digit number of your choice:





Authentication Key

123456

You will need both “Site ID” and “Authentication Key” to setup the upload configuration for WOW in the **Weather Server**.







Figure 32: WOW Server setup screen

				
scroll value up	scroll value down	Scroll field up	Scroll field down	return to Setup

5.10.15.4 Ecowitt.net server setup

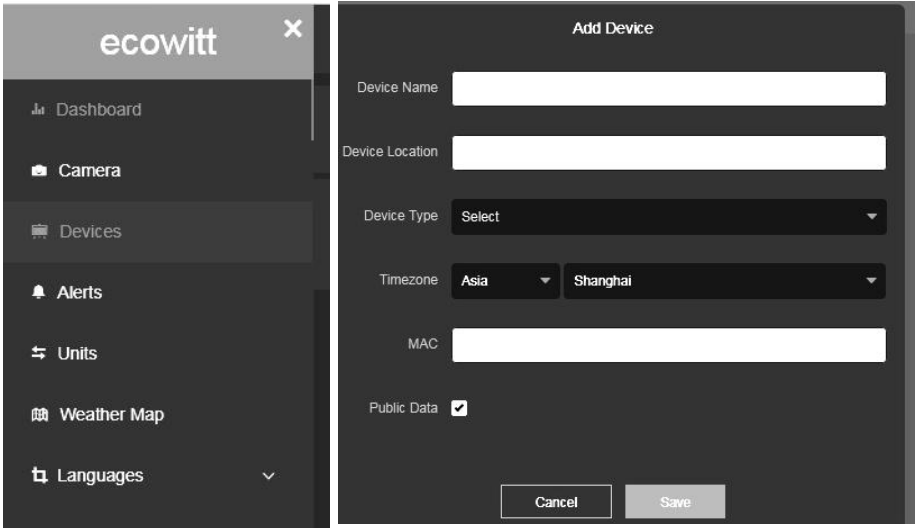

Figure 33: Ecowitt Server setup screen

				
scroll value up	scroll value down	Scroll field up	Scroll field down	return to Setup

To register with Ecowitt follow these steps:

- 1) Visit ecowitt.net and enter Email and Password to sign up.
- 2) Press the upper left menu button and select Devices. Press Add Device and input all the information needed, press save. MAC address found on Ecowitt Server setup screen (Figure33), Note that this is an example only and your MAC address will be different.



Note: When select device address on map, please wait till the map display before select your address.

Note: Please put in the correct time zone to get the correct time. Because the time will be updated to internet time automatically while WIFI connection.

Once registered, select the dashboard to view your data, as shown below:

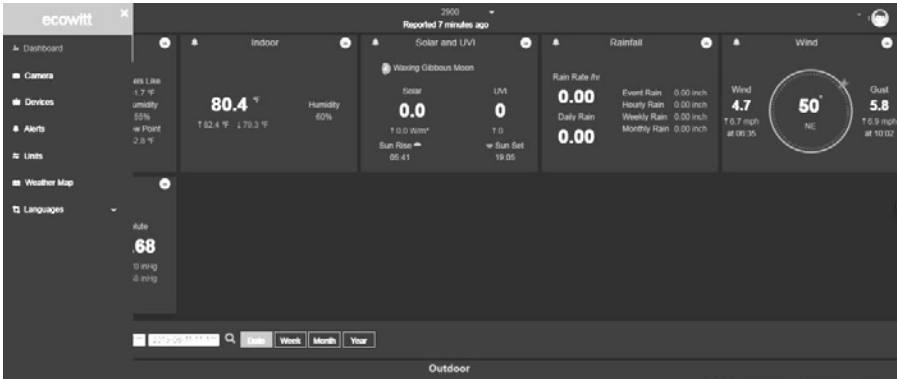

Ecowitt.net is a responsive design and mobile friendly. Simply open your mobile devices web browser, browse to ecowitt.net, and bookmark your dashboard for quick access.

5.11.15.5 Customized server setup

For highly experienced users, it offers the option to send data to the user's own server. Press the "setup" button to enter Customized setup screen,



Figure 34: Server setup screen

Select Enable button and select the protocol type. The website should have the same protocol with Wunderground or Ecowitt. Input all the information needed.

Customized

State

Protocol Type

IP/Hostname

Port

Interval

Station ID

Station Key

Customized

State

Protocol Type

IP/Hostname

Port

Interval

5.10.16 Wi-Fi scan

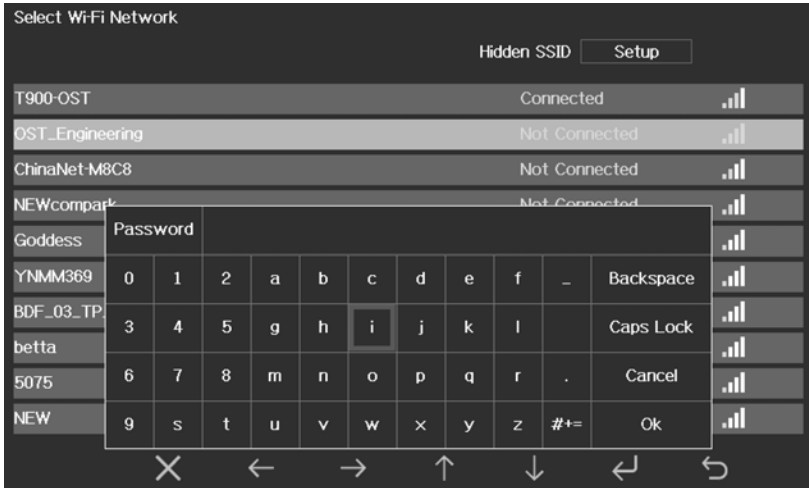





























Figure 35: Select Wi-Fi Network Screen

Press  or  key to select the Wi-Fi network. Press  key to confirm and enter the password. Press  key to return to normal display mode. It is possible that your network is not listed when Wi-Fi Scan is performed. Press  button and restart Wi-Fi Scan, this will usually solve the problem.

Only after connect to WLAN you can upload the data to weather website. If the Wi-Fi network connects successfully, the icon  will show on the left top of the console display. If the data upload to Wunderground.com successfully, the icon  will show on the left top of the console display. If the Wi-Fi network you would like to connect is with a hidden SSID, please follow below steps to connect:

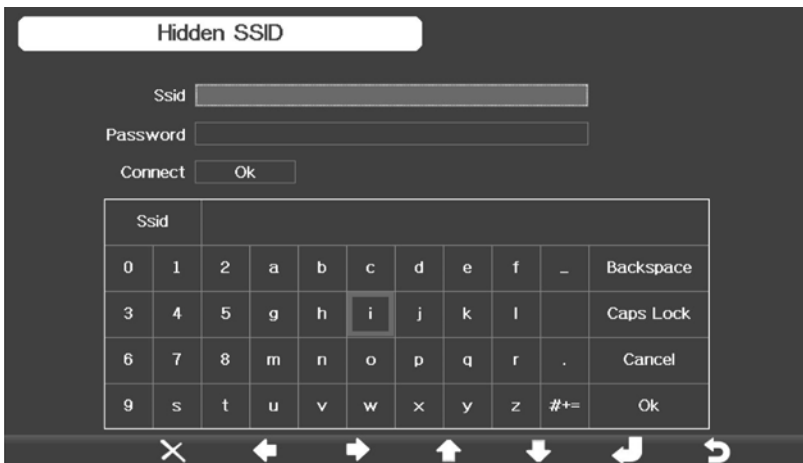

- 1) Press   to select Hidden SSID setup, and press  key directly to enter.
- 2).Press  to highlight the SSID. Press  to display the keyboard and enter your SSID. Press     to scroll to the character and press  to enter the character. Press  to return to the setup page.
- 3). Press  to highlight the Password. Press  to display the keyboard and start to enter your password.. Press     to scroll to the character and press  to enter the character. Press  to return to the setup page.
- 4).Press  to highlight the “OK” button beside “Connect ” to start connecting.

After connected successfully, the status will display” Connected”.

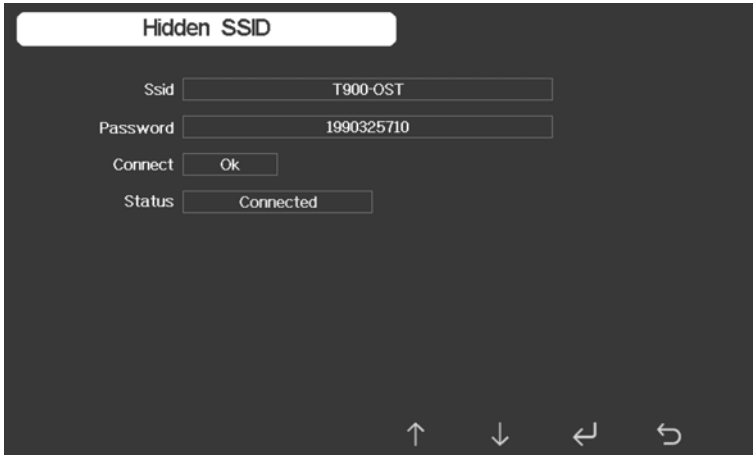





5.10.17 Background

While in Menu Setting Mode, press  key to select Background Setup field, press  or  key to choose between dark background display and light background display

5.10.18 More

This screen is for optional sensors calibration and all sensor ID setup. Press  or  key to enter More mode.

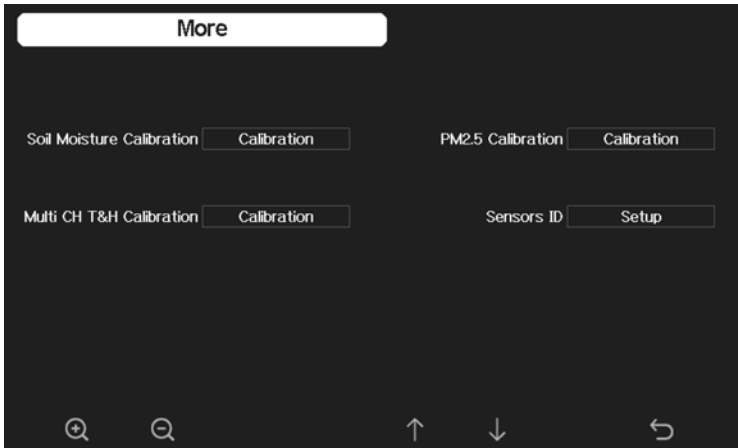





Figure 36: optional sensors calibration and sensor ID setup Screen

Press  or  key to select setting field, press the  or  key to enter option sensors calibration mode or Sensor ID setup mode.

The screenshot shows a dark-themed interface with a white header bar labeled 'Calibration'. Below the header is a table with 8 rows and 7 columns. Each row represents a channel with its current soil moisture percentage, Now AD value, and calibration controls for 0%AD, 100%AD, and a Customize button. A 'Reset' button is located at the end of each row. At the bottom of the screen, there are six navigation icons: a magnifying glass with a plus sign, a magnifying glass with a minus sign, a left arrow, a right arrow, an up arrow, a down arrow, and a back arrow.

Channel	Soil Moisture	Now AD	0%AD	100%AD	Customize	Reset
1	3%	83	70	500	OFF	Reset
2	62%	320	70	500	OFF	Reset
3	0%	26	70	500	OFF	Reset
4	51%	268	70	500	OFF	Reset
5	29%	188	70	500	OFF	Reset
6	0%	26	70	500	OFF	Reset
7	66%	335	70	500	OFF	Reset
8	63%	323	70	500	OFF	Reset

Figure 37: Soil Moisture Calibration Screen

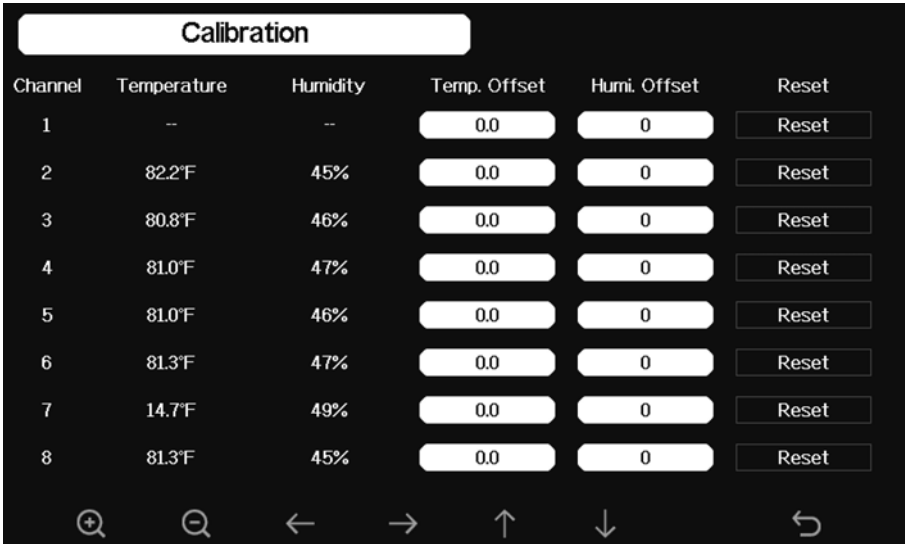

Figure 38: Multi-channel Temperature and Humidity Sensor calibration Screen

Icon	Description
	Select key Press this key to select the unit or scrolls the value
	Select key Press this key to select the unit or scrolls the value.
	Left key Press this key to select the set value.
	Right key Press this key to select the set value.
	Up arrow key Press this key to change the activated option field
	Down arrow key Press this key to change the activated option field
	Return key Press this key to return to previous mode

Sensor	Signal	ID	CH	Sensor	Signal	ID	CH	Sensor	Signal	ID
WH65	📶	2f	1	PM2.5	📶	b9	1	Soil	📶	c4c6
T&HP	📶	49	2	PM2.5	📶	c4ad	2	Soil	📶	c4b5
T&H	📶	88	3	PM2.5	📶	113c7	3	Soil	📶	c4bc
WS80		60029	4	PM2.5	📶	5b	4	Soil	📶	c4a7
WH40		----	1	T&H	📶	8a	5	Soil	📶	c690
WH57		0	2	T&H	📶	77	6	Soil	📶	c561
WH45		16d	3	T&H	📶	65	7	Soil	📶	c51b
WS68		----	4	T&H		bc	8	Soil		----
			5	T&H		66	1	WH55		d4a7
			6	T&H		8e	2	WH55		----
			7	T&H		19	3	WH55		d4a7
			8	T&H		17	4	WH55		----

CH	Sensor	Signal	ID
1	WN34	📶	78
2	WN34	📶	76
3	WN34		----
4	WN34		----
5	WN34		----
6	WN34		----
7	WN34		----
8	WN34		----

Figure 39: Sensors ID setup Screen

This screen list all sensors can work with HP2550 console. This package just included WH65 outdoor sensor array and T&HP (Temperature, humidity and pressure) indoor sensor. These two sensors signal reception status and

ID number will automatically display on the screen if console receives the sensors signal.

The sensor ID is unique and fixed. You can choose **Disable** to disconnect with console, or Register to reconnect with console.

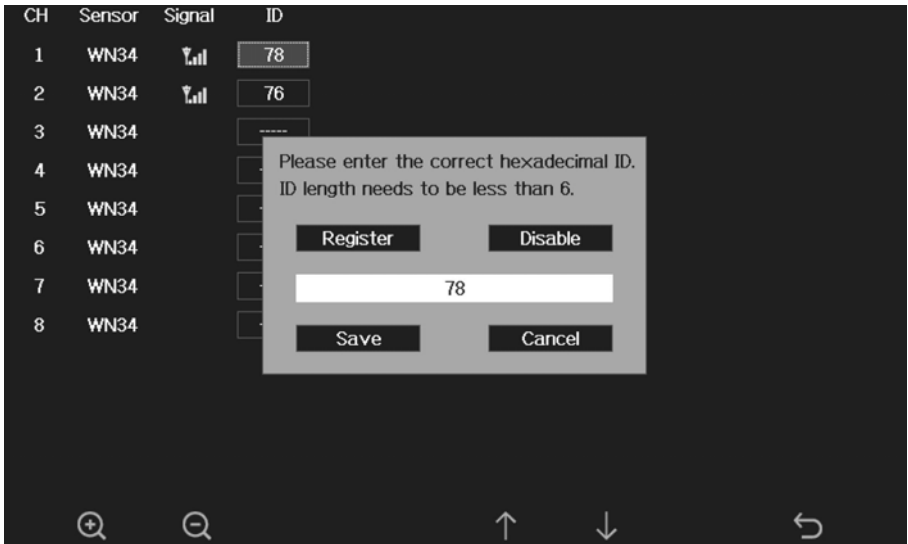

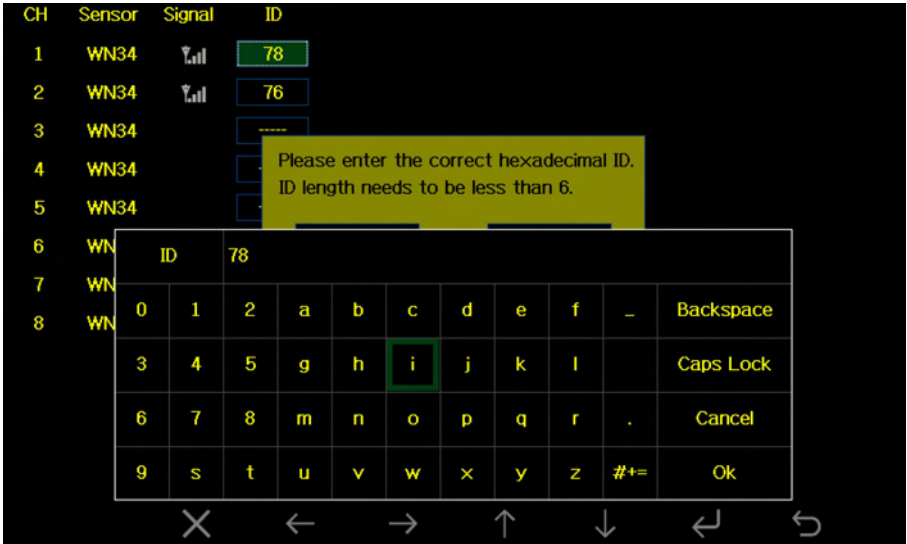

pop up the keyboard or confirm the operation	pop up the keyboard or confirm the operation	Scroll field up	Scroll field down	return to Setup

5.11 Alarm Setting Mode

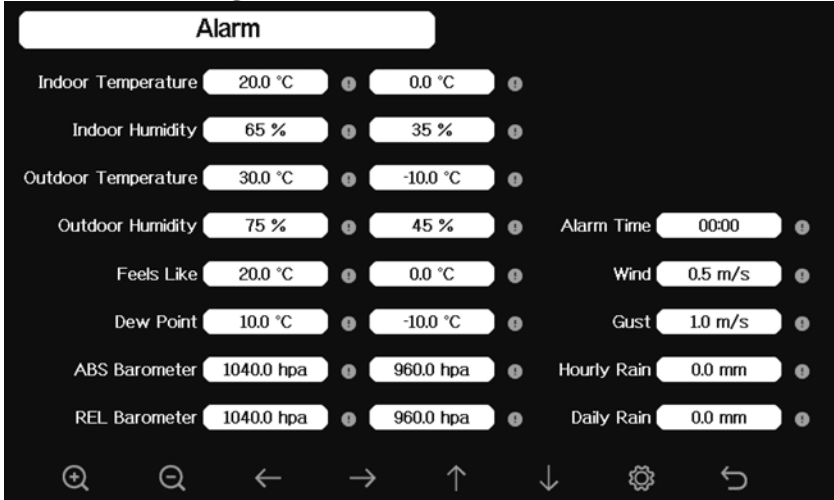









Figure 40: Alarm Setting Screen

Icon	Description
	Select key Press this key to select the unit or scrolls the value
	Select key Press this key to select the unit or scrolls the value.
	Left key Press this key to select the set value.
	Right key Press this key to select the set value.
	Up arrow key Press this key to change the activated option field
	Down arrow key Press this key to change the activated option field
	Set key Press this key to select the Setting sub-Mode
	Return key Press this key to return to previous mode

The first row is high alarm value and the second row is low alarm value.

When weather alarm condition has been triggered, that particular alarm will sound for 120 second and the corresponding icon will flash until the weather condition doesn't meet the user set level. Press any key to mute the alarm.

5.12 Calibration Mode

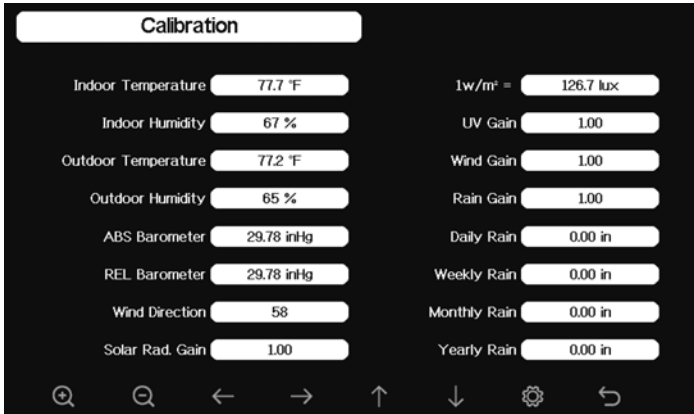





Figure 41: Calibraton Setting Screen

Icon	Description
	Select key Press this key to select the unit or scrolls the value
	Select key Press this key to select the unit or scrolls the value.
	Left key Press this key to select the set value.
	Right key Press this key to select the set value.
	Up arrow key Press this key to change the activated option field
	Down arrow key Press this key to change the activated option field
	Set key Press this key to select the Setting sub-Mode
	Return key Press this key to return to previous mode

To adjust the parameter, press  to scroll to the parameter you wish to change. Press  to highlight the sign (positive vs. negative, if applicable) and significant digit. Press  or  to change the calibrated value.

Parameter	Type of Calibration	Default	Typical Calibration Source
Temperature	Offset	Current Value	Red Spirit or Mercury Thermometer (1)
Humidity	Offset	Current Value	Sling Psychrometer (2)
ABS Barometer	Offset	Current Value	Calibrated laboratory grade barometer
REL Barometer	Offset	Current Value	Local airport (3)
Wind Direction	Offset	Current Value	GPS, Compass (4)
Solar Radiation	Gain	1.00	Calibrated laboratory grade solar radiation sensor
1 w/m ²	Gain	126.7 lux	Solar radiation conversion from lux to w/m ² for wavelength correction (5)
Wind	Gain	1.00	Calibrated laboratory grade wind meter (6)
Rain	Gain	1.00	Sight glass rain gauge with an aperture of at least 4" (7)
Daily Rain	Offset	Current Value	Apply an offset if the weather station was not operating for the entire day.
Weekly Rain	Offset	Current Value	Apply an offset if the weather station was not operating for the entire week.
Monthly Rain	Offset	Current Value	Apply an offset if the weather station was not operating for the entire month.
Yearly Rain	Offset	Current Value	Apply an offset if the weather station was not operating for the entire year.

(1) Temperature errors can occur when a sensor is placed too close to a heat source (such as a building structure, the ground or trees).

To calibrate temperature, we recommend a mercury or red spirit (fluid) thermometer. Bi-metal (dial) and digital thermometers (from other weather stations) are not a good source and have their own margin of error. Using a local weather station in your area is also a poor source due to changes in location, timing (airport weather stations are only updated once per hour) and possible calibration errors (many official weather stations are not properly installed and calibrated).

Place the sensor in a shaded, controlled environment next to the fluid thermometer, and allow the sensor to stabilize for 3 hours. Compare this temperature to the fluid thermometer and adjust the console to match the fluid thermometer.

- (2) Humidity is a difficult parameter to measure electronically and drifts over time due to contamination. In addition, location has an adverse affect on humidity readings (installation over dirt vs. lawn for example).

Official stations recalibrate or replace humidity sensors on a yearly basis. Due to manufacturing tolerances, the humidity is accurate to $\pm 5\%$. To improve this accuracy, the indoor and outdoor humidity can be calibrated using an accurate source, such as a sling psychrometer.

- (3) The display console displays two different pressures: absolute (measured) and relative (corrected to sea-level).

To compare pressure conditions from one location to another, meteorologists correct pressure to sea-level conditions. Because the air pressure decreases as you rise in altitude, the sea-level corrected pressure (the pressure your location would be at if located at sea-level) is generally higher than your measured pressure.

Thus, your absolute pressure may read 28.62 inHg (969 mb) at an altitude of 1000 feet (305 m), but the relative pressure is 30.00 inHg (1016 mb).

The standard sea-level pressure is 29.92 in Hg (1013 mb). This is the average sea-level pressure around the world. Relative pressure measurements greater than 29.92 inHg (1013 mb) are considered high pressure and relative pressure measurements less than 29.92 inHg are considered low pressure.

To determine the relative pressure for your location, locate an official reporting station near you (the internet is the best source for real time barometer conditions, such as Weather.com or Wunderground.com), and set your weather station to match the official reporting station.

- (4) Only use this if you improperly installed the weather station sensor array, and did not point the direction reference to true north.
- (5) The default conversion factor based on the wavelength for bright sunlight is $126.7 \text{ lux} / \text{w/m}^2$. This variable can be adjusted by photovoltaic experts based on the light wavelength of interest, but for most weather station owners, is accurate for typical applications, such as calculating evapotranspiration and solar panel efficiency.
- (6) Wind speed is the most sensitive to installation constraints. The rule of thumb for properly installing a wind speed sensor is 4 x the distance of the tallest obstruction. For example, if your house is 20' tall and you mount the sensor on a 5' pole:

$$\text{Distance} = 4 \times (20 - 5)' = 60' \text{ or } = 4 \times (6.10 - 1.52) = 18.32\text{m.}$$

Many installations are not perfect and installing the weather station on a roof can be difficult. Thus, you can calibrate for this error with a wind speed multiplier.

In addition to the installation challenges, wind cup bearings (moving parts) wear over time.

Without a calibrated source, wind speed can be difficult to measure. We recommend using a calibrated wind meter (not included) and a constant speed, high speed fan.

- (7) The rain collector is calibrated at the factory based on the funnel diameter. The bucket tips every 0.01” or 0.1m of rain (referred to as resolution). The accumulated rainfall can be compared to a sight glass rain gauge with an aperture of at least 4” or 0.1m. Make sure you periodically clean the rain gauge funnel.

Note: The purpose of calibration is to fine tune or correct for any sensor error associated with the devices margin of error. Errors can occur due to electronic variation (example, the temperature sensor is a resistive thermal device or RTD, the humidity sensor is a capacitance device), mechanical variation, or degradation (wearing of moving parts, contamination of sensors).

Calibration is only useful if you have a known calibrated source you can compare it against, and is optional. This section discusses practices, procedures and sources for sensor calibration to reduce manufacturing and degradation errors. Do not compare your readings obtained from sources such as the internet, radio, television or newspapers. The purpose of your weather station is to measure conditions of your surroundings, which vary significantly from location to location.

NOTE: UV Calibration MUST be performed every 2 to 3 months to









improve results. Over time, UV Index may alter results based on bright and strong sunlight conditions. This is why diligent UV Calibration is recommended.

5.13 Factory reset



Figure 42: Factory Reset Screen

5.13.1 Re-register indoor transmitter





Press  or  key to select re-register indoor transmitter. Press  or  key to popup the Message Box "Register a new indoor transmitter?" Press  or  to select Yes or No. Press the  or  key to confirm the selection.

5.13.2 Re-register outdoor transmitter

Please reference section 6.7.1. Procedures and settings are similar to re-register indoor transmitter









5.13.3 Automatic Clear Max/Min

To turn on/off automatically clear Max/Min record at 0:00hr every day.









Press  or  key to select Automatic clear Max/Min. Press  or  key to switch on/off.

When it is selected with ON option, min/max will be presented as daily min/max, and with OFF option selected, it is for history min/max record.









5.13.4 Reset to Factory

Press  or  key to select Reset to Factory. Press  or  key to popup the Message Box "Reset to factory default?" Press  or  to select Yes or No. Press the  or  key to confirm the selection.









5.13.5 Clear History

Press  or  key to select Clear History. Press  or  key to popup the Message Box "Clear the history record?" Press  or  to select Yes or No. Press the  or  key to confirm the selection.

5.13.6 Clear Max/Min

Press  or  key to select Clear Max/Min. Press  or  key to popup the Message Box "Clear the max/min record?" Press  or  to select Yes or No. Press the  or  key to confirm the selection.

5.13.7 Backup data

Press  or  key to select Backup data. Press  or  key to popup the Message Box "Copy history data to SD card?" Press  or  to select OK or Cancel. Press the  or  key to confirm the selection.

Note: You need to insert a SD card(not included) into the console before using this function.





5.13.8 About information



Figure 43: About information Screen

Note: This figure is just for reference(model and frequency will change according to different market). The actual display console may be with higher firmware version than this manual described because we will update the firmware occasionally.

5.13.9 Language

Press  or  key to select Language. Press  or  key to switch different language display.

6. Other Console Functions

6.1 Beaufort Wind Force Scale

If you have selected the use of Beaufort wind speed units, you can use the table below for reference. The Beaufort scale is based on qualitative wind conditions and how they would affect a ship's (frigate) sails (so yes, it is an "old" standard). It is therefore less precise than the other scales but is still in use in various locales.





Wind speed	Beaufort number	Description
0 - 1 mph, or 0 - 1.6 km/h	0	Calm
1 - 3 mph, or 1.6 - 4.8 km/h	1	Light air
3 - 7 mph, or 4.8 - 11.3 km/h	2	Light breeze
7 - 12 mph, or 11.3 - 19.3 km/h	3	Gentle breeze
12 - 18 mph, or 19.3 - 29.0 km/h	4	Moderate breeze
18 - 24 mph, or 29.0 - 38.6 km/h	5	Fresh breeze
24 - 31 mph, or 38.6 - 49.9 km/h	6	String breeze
31 - 38 mph, or 49.9 - 61.2 km/h	7	Near gale
38 - 46 mph, or 61.2 - 74.1 km/h	8	Gale
46 - 54 mph, or 74.1 - 86.9 km/h	9	Strong gale
55 - 63 mph, or 88.5 - 101.4 km/h	10	Storm
64 - 73 mph, or 103 - 117.5 km/h	11	Violent storm
74 mph and above, or 119.1 km/h and above	12	Hurricane

Table: Beaufort wind force scale

6.2 Weather Forecasting

The five weather icons are Sunny, Partly Cloudy, Cloudy, Rainy and Stormy.

The forecast icon is based on the rate of change of barometric pressure. Please allow at least **one month** for the weather station to learn the barometric pressure over time.

Sunny	Partly Cloudy	Cloudy
		
Pressure increases for a sustained period of time	Pressure increases slightly or initial power up	Pressure decreases slightly
Rainy	Stormy	
		
Pressure decreases for a sustained period of time	Pressure rapidly decreases	

6.3 Lightning Alert

The lightning icon  will appear if the Dew Point exceeds 70 F. This means there is a chance of lightning storms forming.

6.4 Weather Forecasting Description and Limitations











In general, if the rate of change of pressure increases, the weather is generally improving (sunny to partly cloudy). If the rate of change of pressure decreases, the weather is generally degrading (cloudy, rainy or stormy). If the rate of change is relatively steady, it will read partly cloudy.

















The reason the current conditions do not match the forecast icon is because the forecast is a prediction 24-48 hours in advance. In most locations, this prediction is only 70% accurate and it is a good idea to consult the National Weather Service for more accurate weather forecasts. In some locations, this prediction may be less or more accurate. However, it is still an interesting educational tool for learning why the weather changes.

The National Weather Service (and other weather services such as Accuweather and The Weather Channel) have many tools at their disposal to predict weather conditions, including weather radar, weather models, and detailed mapping of ground conditions.

6.5 Moon Phase

In the event the moon phase is 100%, the icon  will appear in its place. In the event of 0%, the word “New Moon” will appear in its place.

Moon Phase	Image	Moon Phase	Image
Day 1		Day 14	
Day 2		Day 15	
Day 3		Day 16	
Day 4		Day 17	
Day 5		Day 18	

Day 6		Day 19	
Day 7		Day 20	
Day 8		Day 21	
Day 9		Day 22	
Day 10		Day 23	
Day 11		Day 24	
Day 12		Day 25	
Day 13 Full Moon		Day 26 New Moon	

7. Maintenance

The following steps should be taken for proper maintenance of your station

1. Clean the rain gauge once every 3 months. Rotate the funnel counter-clockwise and lift to expose the rain gauge mechanism, and clean with a damp cloth. Remove any dirt, debris and insects. If bug infestation is an issue, spray the array lightly with insecticide.

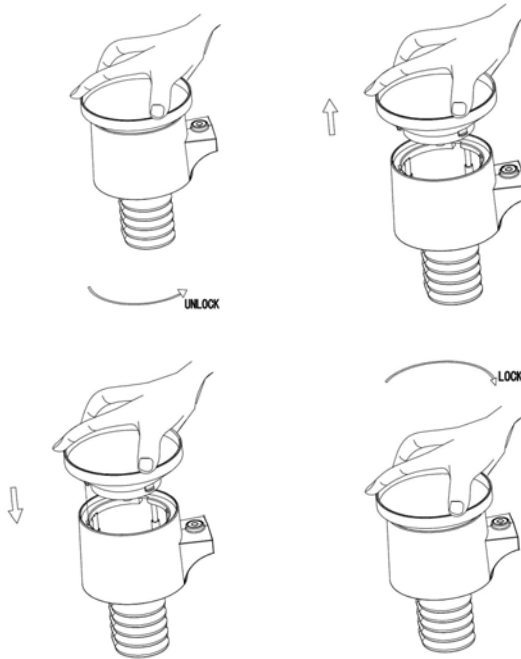

Figure 44: Rain gauge maintenance

2. Clean the solar radiation sensor and solar panel every 3 months with a non-abrasive slightly damp cloth.

3. Replace batteries every 1-2 years. If left in too long, the batteries may leak due to environmental challenges. In harsh environments, inspect the batteries every 3 months (while cleaning the solar panel).

4. When replacing the batteries, apply a corrosion preventing compound on the battery terminals, available at Amazon and most hardware stores.

5. In snowy environments, spray the top of the weather station with anti-icing silicon spray to prevent snow build up.



8. Troubleshooting Guide

Look through the following table and locate an issue or problem you are experiencing in the left column and read possible solutions in the right column.

Problem	Solution
<p>Wireless remote (thermo-hygrometer) not reporting in to console.</p> <p>There are dashes on the display console.</p>	<p>The maximum line of sight communication range is about 150m. Move the sensor assembly closer to the display console.</p> <p>Resynchronize the remote sensor(s). Reference Section 5.13.1&5.13.2.</p> <p>Install a fresh set of batteries in the remote sensor(s).</p> <p>Make sure the remote sensors are not transmitting through solid metal (acts as an RF shield), or earth barrier (down a hill). Radio Frequency (RF) Sensors cannot transmit through metal barriers (example, aluminum siding) or multiple, thick walls.</p> <p>Move the display console around electrical noise generating devices, such as computers, TVs and other wireless transmitters or receivers.</p>
<p>Outdoor sensor array does not communicate to the display console.</p>	<p>The sensor array may have initiated properly and the data is registered by the console as invalid, and the console must be reset. Press the reset button as described in Section Installation.</p> <p>With an open ended paperclip, press the reset button for 3 seconds to completely discharge the voltage.</p> <p>Take out the batteries and wait one minute, while covering the solar panel to drain the voltage.</p>

Problem	Solution
	<p>Put batteries back in and resync with console by powering down and up the console with the sensor array about 10 feet away.</p> <p>Bring the sensor array inside the house (you can disconnect it from the rest of the sensors). The LED next to the battery compartment will flash every 16 seconds. If the LED is not flashing every 16 seconds...</p> <p>Replace the batteries in the outside sensor array. If the batteries were recently replaced, check the polarity. If the sensor is flashing every 48 seconds, proceed to the next step.</p> <p>There may be a temporary loss of communication due to reception loss related to interference or other location factors,</p> <p>or the batteries may have been changed in the sensor array and the console has not been reset. The solution may be as simple as powering down and up the console.</p> <p>Replace the batteries in the outside sensor array.</p> <p>With the sensor array and console 10 feet away from each other, remove AC power from the display console and wait 10 seconds. Re-connect power.</p>
<p>Temperature sensor reads too high in the day time.</p>	<p>Make certain that the sensor array is not too close to heat generating sources or structures, such as buildings, pavement, walls or air conditioning units.</p> <p>Use the calibration feature to offset installation issues related to radiant heat sources. Reference 6.6.</p>

Problem	Solution
<p>Absolute pressure does not agree with official reporting station</p>	<p>You may be viewing the relative pressure, not the absolute pressure.</p> <p>Select the absolute pressure. Make sure you properly calibrate the sensor to an official local weather station. Reference Section 5.12 for details.</p>
<p>Rain gauge reports rain when it is not raining</p>	<p>An unstable mounting solution (sway in the mounting pole) may result in the tipping bucket incorrectly incrementing rainfall. Make sure you have a stable, level mounting solution.</p>
<p>Data not reporting to Wunderground.com</p>	<ol style="list-style-type: none"> <li data-bbox="467 544 1014 826">1. Confirm your password is correct. It is the password you registered on Wunderground.com. Your Wunderground.com password cannot begin with a non-alphanumeric character (a limitation of Wunderground.com, not the station). Example, \$oewkrf is not a valid password, but oewkrf\$ is valid. <li data-bbox="467 858 1014 1034">2. Confirm your station ID is correct. The station ID is all caps, and the most common issue is substituting an O for a 0 (or visa versa). Example, KAZPHOEN11, not KAZPH0EN11 <li data-bbox="467 1066 1014 1177">3. Make sure the date and time is correct on the console. If incorrect, you may be reporting old data, not real time data. <li data-bbox="467 1209 1014 1321">4. Make sure your time zone is set properly. If incorrect, you may be reporting old data, not real time data. <li data-bbox="467 1353 1014 1449">5. Check your router firewall settings. The console sends data via Port 80.

Problem	Solution
No WiFi connection	<ol style="list-style-type: none"><li data-bbox="464 151 999 422">1. Check for WiFi signal strength symbol on the display . If wireless connectivity is successful and reporting to Wunderground.com, the WiFi icon  will be displayed the home page.<li data-bbox="464 486 999 598">2. Make sure your modem WiFi settings are correct (network name, password and security settings).

9. Glossary of Common Terms

TERM	DESCRIPTION
ABSOLUTE AIR PRESSURE ABSOLUTE BAROMETRIC PRESSURE	Absolute air pressure is the air pressure registered on a barometer without regard to altitude.
BAROMETER	A barometer is a device that measures the pressure of the air pushing on it—this measurement is called the barometric pressure. We don't actually feel the barometric pressure because the air pressure is pushing equally in every direction.
BEAUFORT (Bft)	An indicator of wind force strength (not speed) as it would act on a ship's sails. Still commonly in used in some locales to indicate wind force.
DEW POINT	The temperature to which air must be cooled to become saturated with water vapor. When further cooled, the airborne water vapor will condense to form liquid water (dew), or frost if below freezing.
HEAT INDEX	The heat index (HI) or humiture is an index that combines air temperature and relative humidity, in shaded areas, as an attempt to determine the human-perceived equivalent temperature, as how hot it would feel if the humidity were some other value in the shade.
HECTOPASCALS (hPa)	This is an international standard (SI system) for measuring air pressure. It used to be referred to as milli-bar (mb) and sometimes still is. They are equivalent.

TERM	DESCRIPTION
HYGROMETER	An instrument that measure relative humidity of the air. This is expressed as a percentage between 0% and 100%.
INCHES OF MERCURY (inHg)	This is the common unit of measurement for air pressure in the United States. It refers to the length of a standard column of mercury (a liquid metal) that can be pushed up by the ambient air pressure. Standard pressure is approximately 29.92 inHg
KNOTS (kn)	One knot is equivalent to one nautical mile and is sometimes used to indicate wind speed.
LCD	An acronym for “Liquid Crystal Display.” This is a common type of display screen used in televisions, computers, watches, and digital clocks.
LUX (lx)	The unit of illuminance (a measure of the intensity of illumination on a surface) as used in the SI system.
MILLIBAR (mb)	See HECTOPASCALS.
MM OF MERCURY (mmHg)	This is similar to inches of mercury, except expressed in millimeters. Standard pressure is approximately 760 mmHg.
NIST	National Institute of Standards and Technology. A United States institute that keeps very accurate time using atomic clocks and provides an internet-based service to accurately set device clocks.
RELATIVE AIR PRESSURE RELATIVE BAROMETRIC PRESSURE	Relative air pressure is the absolute air pressure compensated for the altitude of the barometer. The result is what the air pressure would be at sea level.
TFT	Thin-Film-Transistor, a type of LCD screen.

TERM	DESCRIPTION
ULTRA VIOLET INDEX	<p>The ultraviolet index or UV-Index (UVI) is an international standard measurement of the strength of sunburn-producing ultraviolet (UV) radiation at a particular place and time. The purpose of the UV Index is to help people effectively protect themselves from UV radiation. The UV Index is a linear scale, with higher values representing a greater risk of sunburn (which is correlated with other health risks) due to UV exposure. An index of 0 corresponds to zero UV radiation, as is essentially the case at night. An index of 10 corresponds roughly to midday summer sunlight with a clear sky when the UV Index was originally designed, but values above 10 are sometimes possible. Levels above 8 are considered “very high” and above 11 are considered “extreme.”</p>
WIND CHILL	<p>Wind chill (popularly wind chill factor) is the lowering of body temperature due to the passing-flow of lower-temperature air. In other words, the air “feels” colder than it is because of the chilling effect of the wind on the skin.</p>

Table: Glossary of terms

10. Specifications

Note: Out of range values will be displayed using “---”:

Outdoor sensor	Specification
Transmission distance in open field	100 m (330 ft.)
RF Frequency	433 / 868 MHz depending on location
Temperature range	-40°C – 60°C (-40°F - 140°F)
Temperature accuracy	± 1°C, or ± 2°F
Temperature resolution	0.1°C, or 0.1°F
Humidity range	10% ~ 99%
Humidity accuracy	± 5%
Humidity resolution	1%
Rain volume display range	0 – 9999 mm, or 0 – 199.99 in
Rain volume accuracy	± 10%
Rain volume resolution	0.3 mm (for volume < 1,000 mm) 1 mm (for volume ≥ 1,000 mm), or 0.01 in (for volume < 100 in) 1 mm (for volume ≥ 100 in)
Wind speed range	0 – 50 m/s (0 ~ 100 mph)
Wind speed accuracy	± 1 m/s (speed < 5 m/s) ± 10% (speed ≥ 5 m/s), or ± 0.1 mph (speed < 11 mph) ± 10% (speed ≥ 11 mph)
UV-Index range	0 - 15
Light range	0 – 120 kLux
Light accuracy	± 15%
Sensor reporting interval	16 seconds

Table: Outdoor sensor specification

Indoor sensor	Specification
Temperature range	-10°C – 60°C (14°F - 140°F)
Temperature resolution	0.1°C, or 0.1°F
Humidity range	10% ~ 99%
Humidity resolution	1%
Barometric pressure range	300 – 1,100 hPa (8.85 – 32.5 inHg)
Barometric pressure accuracy	± 3 hPa in 700 – 1,100 hPa range
Barometric pressure resolution	0.1 hPa (0.01 inHg)
Sensor reporting interval	60 seconds
Alarm Duration	120 seconds

Table: Indoor sensor specification

Power	Specification
Base station/console	5V DC Adapter (included)
Indoor sensor	2 x AA 1.5 Alkaline batteries (not included)
Outdoor sensor	Solar panel (built-in)
Outdoor sensor (backup)	2 x AA 1.5V LR6 Alkaline (not included), or 2 x AA 1.5V Lithium battery (not included)

Table: Power specification

The primary power source for the outdoor sensor is the solar panel. When available solar power (light over recent period) is insufficient, the batteries will be used. In outdoor climates that frequently have sustained temperatures below 0°C (or 32°F) the use of Lithium batteries is strongly suggested as these are performing better than Alkaline batteries under such circumstances.

Caution !

This booklet may contain errors or misprints. The information is contains is regularly checked and correction are included in subsequence editions. We disclaim any responsibility for any printing error, or their consequences. The specification of this product may change without prior notice.