



CleanAHull Ultrasonic Antifouling Installation / User Manual

Models: CLHUD / CLHUQ



Globatech Australia / CleanABoat.com
Contact: info@cleanaboat.com / www.cleanaboat.com
(Blue Ice Company Pty Ltd, ACN 121 390 252)
11 \ 75 Waterway Drive
Coomera, 4209
QLD, Australia

Congratulations on your purchase of your new Ultrasonic Antifouling System!

CleanAHull Advanced Ultrasonic Antifouling Systems are designed for the prevention of algae and other sea growth. Developed to extend the life of existing anti foul paint coatings and in turn provide vastly improved performance, improved fuel economy, reduced haul outs, reduced running costs all while being environmentally friendly.

This device uses an advanced Digital Ultrasonic sound wave system and as such does not penetrate or interfere with the hull. Our system mounts to the inside of your hull using the provided high quality mounting and bonding agent.

Because of our simple installation method the system can be installed with the boat in the water or out of the water without any concerns.

Our system is the most Advanced Micro controlled Digital Ultrasonic System available and once it is installed and turned on it just works! Our advanced system is Designed and Manufactured in Australia and is made from the highest quality components available.

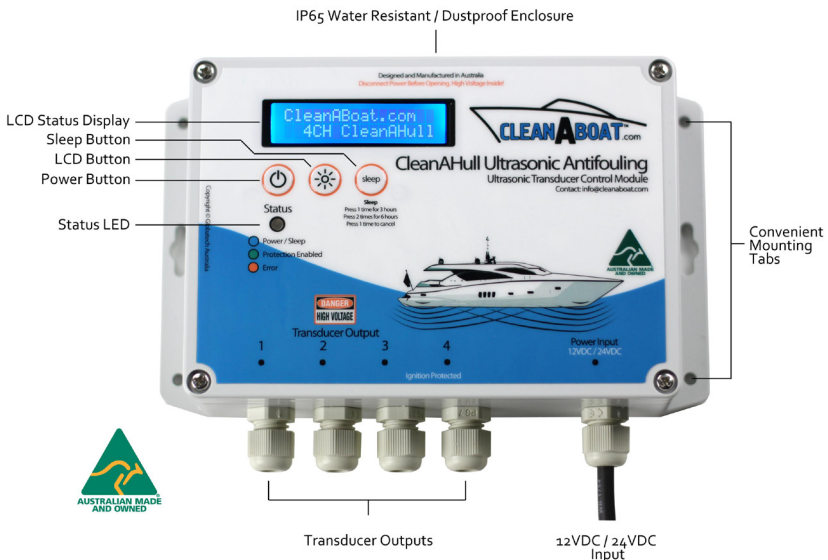

Overview

Outlined below in this Installation / Instruction Manual is a brief overview of the most effective way to install the CleanAHull Advanced Ultrasonic Antifouling System. Following this installation manual will result in the most effective installation and timely install.

1. Planning & Transducer Positioning

2. Fitting the Transducer(s) / Transducer Footprints

- Installation on GRP / Fiberglass
- Installation on Bare Steel / Aluminium
- Installation on Painted Steel / Aluminium
- Direct Transducer Bonding Installation

3. Installation of the Control Module & Running of Cables

- Running of Power and Transducer Cables
- Transducer Cable Termination
- Powering on and Systems Checks

4. User Manual / General Operation

5. Troubleshooting

6. Maintenance

7. Warranty Policy

SAFETY CONCERNS

WARNING! Electrical Safety

The 12-24VDC power supply to the device MUST be protected by a suitable in line fuse or circuit breaker on the positive wire. Fuse Ratings outlined in wiring instructions below.

It is highly recommended that the electrical connections should be carried out by a qualified electrician.

WARNING! Cable Connections

Prior to opening the unit or connecting any transducer cables you must ensure the unit is switched OFF and the in line fuse is removed, if a circuit breaker was used ensure it is OFF. Failure to do so may cause damage to the unit OR to your person.

WARNING! Performance

Our CleanAHull Ultrasonic Antifouling System must be installed in accordance with the instructions provided in this installation user manual. Failure to install correctly may result in reduced performance and effectiveness, or cause personal injury and/or damage to property.

WARNING!

It is advised that you do not dive under the hull for any extended period of time whilst the system is operating. We recommend putting the system into sleep mode whilst diving under the hull.

DISCLAIMER

Due to the nature of the vessels this product is installed in, there may be confined spaces ie. in the bottom or "bilge" of a boat. There may be residual fuel or other fumes in this space so extreme care and safety must be exercised at all times. During the installation of this system you may be in a claustrophobic environment, we advise that an observer/assistant is with you at all times when you undertake this installation.

You will need to know a few skills if you are to correctly perform the installation yourself. It would be beneficial to have experience with;

- * Sanding
- * Drilling
- * Familiarity with mixing and handling of epoxy bonding resins and glues and their application process
- * A moderate understanding of electronics including your vessels configuration.

The success of this product is directly proportional to the quality of the installation.

If you are unsure if you are capable of performing the installation or have any questions, concerns or doubts about what is mentioned here or the procedure outlined for the actual installation in this user manual we advise you contact us or employ a CleanABoat installer or shipwright/marine electrician to perform the installation for you. Globatech Australia / CleanABoat can take no responsibility for a defective installation, nor injury or damage to persons or property.

IMPORTANT: Read this manual in it's entirety prior to commencing any of the installation process.

Purchasers Obligation

It is the Purchaser/Vessel owner/Skippers/Engineers responsibility to regularly check on the operation of the CleanAHull System to ensure it is operating correctly and the Ultrasonic Protection is active.

Anti foul / Bottom Paint Coatings

Follow Manufacturers instructions thoroughly to ensure correct adhesion and longevity of the coating.

1. Planning & Transducer Positioning

Prior to installation it is important to plan out the process; including hull design (3/4 Keel/Full Keel/No Keel), single or twin props, single or twin stern drives, hull / targeted protection, transducer positioning, cable runs, power supply and control module location. It is also important to ensure you have specified the correct number of Transducers for adequate protection.

Transducer Positioning

Transducer mounting positions are important as the success of your installation is governed by the effectiveness of the transference of Ultrasonic Sound waves into the hull of the vessel. For this reason we will give you instruction and guidance on how to select the most appropriate locations and what to avoid when selecting the location.

Visit www.CleanABOat.com for installation galleries and more information on alternate mounting positions.

Hull Construction

Of great importance is the construction material of the hull. Due to the nature of ultrasonic sound waves it is critical that your hull be of a construction material that lends itself to the easy propagation of ultrasonic sound. GRP/ Fiberglass (Glass Re-enforced Plastic), Aluminium, Steel, Kevlar and Carbon Fibre are the only construction materials that ultrasonic antifouling will work on.

Hull Mounting

It is important to ensure you are bonding your transducer directly onto the hull, ensuring you are not bonding to a false floor, cavity, over a keel, or on the inner layer of a balsa/foam cored vessel.

Obstructions

Avoid mounting your transducers close to any large objects which may act as obstructions to the Ultrasonic sound waves. This includes things such as water tanks, bulkheads, bearers, stringers, transom, fuel tanks, etc. It is best to be at least 30cm from any such obstruction.

It is also best to avoid mounting the Transducer(s) close to any Depth Sounder or Fish Finder.

Positioning

Image right is a guide to the actual locations that we have found works best. Use this as a guide to find suitable locations in your vessel. Also refer to the above instructions, Hull Construction, Hull Mounting and Obstructions to assist in the final location positions.

Larger Vessels / Commercial Applications

Depicted here are vessels typically up to ~15m in length for information relating to larger vessels and recommended transducer locations it is best to contact us at www.cleanaboat.com / info@cleanaboat.com for assistance and more information on transducer locations, etc.

Targeting Protection

Protection can be targeted to objects by mounting a transducer directly onto the object. This can be performed for protection of Stern and Bow thrusters and their tunnels, sea strainers, piping, rudders, foils, stern drive legs, stabilisers, trim tabs, etc. If you would like more information on the suitable applications please feel free to visit us at www.cleanaboat.com or contact us via email at info@cleanaboat.com and we would be happy to discuss your installation.

Cable Runs

Each transducer requires it's cable to be run back to the corresponding control module for electrical connection. It is generally a good idea to ensure there is a safe cable run back to the desired control module location prior to installing the transducer(s). When running cables it is good practice to encase the exposed cable within conduit where possible, this ensures there will be minimal chance of foreign interaction with the cable. It is also advisable where possible to avoid long runs where the Transducer cable is paired along side other critical cabling, in this scenario a gap between the cables of ~20cm should be used and when passing across this should be done perpendicular. Do not install cables where they will be submerged in bilge water for extended periods of time.

Power Supply

A 12 or 24 VDC Battery power supply is required to power the CleanABOat Ultrasonic Antifouling system. While the Ultrasonic Antifouling system typically draws only an average of ~200mAh for each transducer installed, it does need a good battery supply to support the peak output periods. A Shore power or Solar panel battery charger system should be in place to ensure 100% battery supply is maintained. It is recommended to power directly from your batteries with an in-line fuse.

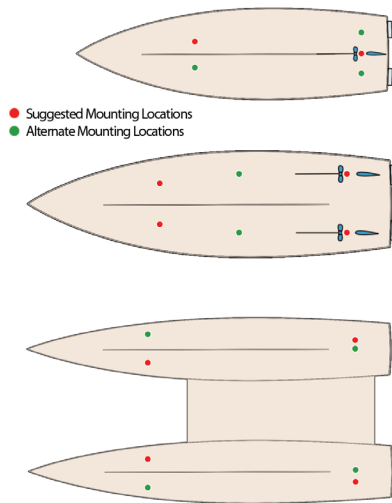

2. Fitting the Transducer(s) / Transducer Footprints

Surface Preparation

Preparation of the hull surface is very important and this process should be followed carefully. Below we cover surface preparation for GRP/Fiberglass, Bare Steel / Aluminium & Painted Steel / Aluminium. The initial stages of preparation vary slightly so please choose the appropriate surface instructions below. Visit www.cleanaboat.com for Instructional Videos.

1. Mark the desired mounting location

We first begin by marking out the desired mounting location, this is the same for all surfaces and gives a rough guide of the area we are working on.

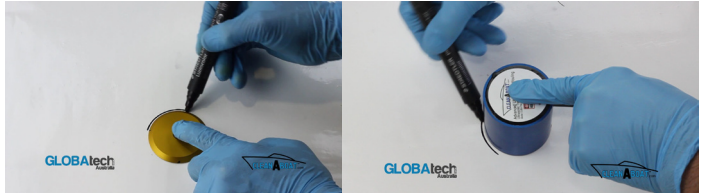

2. Surface Preparation

Next we will prepare the area to be bonded to by sanding it with 60 Grit sand paper. This will remove any top coating of paint/gel coat or surface oxidation and provide a clean keyed surface for bonding with JB Weld adhesive. This process varies slightly between GRP/Fiberglass, painted steel / aluminium and bare steel / aluminium so below is outlined all three surface preparation procedures.

Fiberglass / GRP (Glass Re-enforced Plastic)

Using 60 grit sand paper sand away the top flow coat/gel coat to reveal the fiberglass. Ensure the prepared area is level and keyed to the 60 grit sand paper.

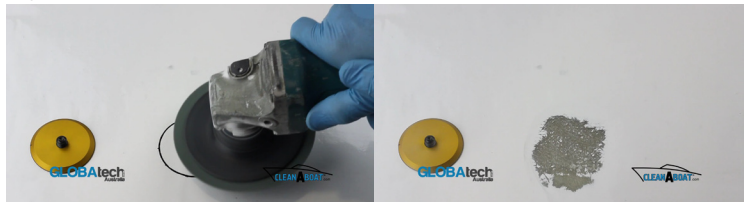

Painted Steel / Painted Aluminium

Using 60 grit sand paper sand away the paint to reveal the bare steel / aluminium. Ensure the prepared area is flat and keyed to the 60 grit sand paper.

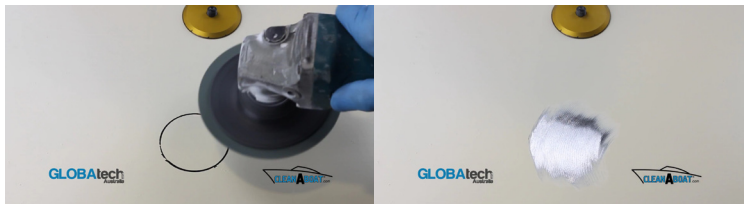

Bare Steel / Bare Aluminium

Using 60 grit sand paper sand the bare steel / aluminium to ensure the prepared area is flat and keyed to the 60 grit sand paper.

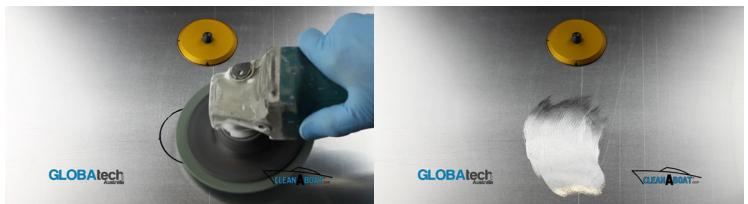

Mounting the Transducer using the Footprint

3. Clean Surfaces Thoroughly

Clean both the hull and the base of the footprint thoroughly using Acetone and a clean rag. It is important that all surfaces to be bonded are clean of any dust or debris.



4. Mix JB Weld Adhesive

Dispense equal parts of JB Weld Adhesive onto a clean mixing board and thoroughly mix until a uniform dark grey colour is achieved. Ensure no air bubbles have been mixed in.



5. Apply JB Weld Adhesive & Place Footprint

Apply a large amount of the mixed JB Weld adhesive to the base of the CleanA-Hull Footprint and press the Footprint into position, twisting left and right while applying downward pressure to ensure a perfect full face contact with the hull and that there are no air cavities.



6. Clean Footprint Face & Tape Down

Carefully clean the top face of the footprint and thread to ensure no JB Weld adhesive or other debris present. Tape footprint in position to ensure it does not move while the adhesive cures. Curing should occur over a period of 24 hours, please allow longer in cold climates.



7. Remove Tape, Clean Surfaces & Apply loctite 515

After the JB Weld adhesive has cured (24 Hours +) remove the tape and proceed to clean both the face of the footprint and the face of the transducer to be installed with acetone on a clean rag. Then apply the loctite 515 to the face of the transducer as shown.



8. Install Transducer onto Footprint as tight as possible by hand

While holding the loop of cable in one hand and the Transducer in the other, carefully screw the transducer down onto the footprint as tight as possible by hand. Continue on to running the transducer cable, however allow 24 Hours before powering the system up to allow the loctite 515 to cure. Ensure Transducer and footprint face are in perfect contact.



Bonding the Transducer without using the Footprint

The transducers can be fitted to the hull without the use of the footprint. This method of installation is a harder to achieve in some situations and should be avoided on steep surfaces. The step below continue on after step 2 to show the bonding of the transducers directly. All surfaces must be prepared in accordance with Steps 1 and 2.

3. Clean Surfaces Thoroughly

Clean both the hull and the base of the footprint thoroughly using Acetone and a clean rag. It is important that all surfaces to be bonded are clean of any dust or debris.



4. Mix JB Weld Adhesive

Dispense equal parts of JB Weld Adhesive onto a clean mixing board and thoroughly mix until a uniform dark grey colour is achieved. Ensure no air bubbles have been mixed in.

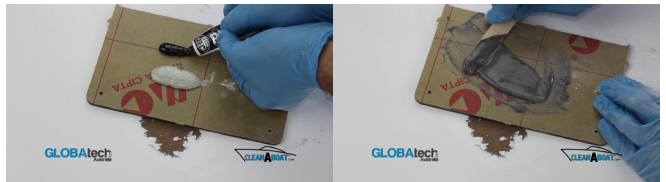

5. Apply JB Weld Adhesive & Place Transducer

Apply a large amount of the mixed JB Weld adhesive to the base of the CleanA-Hull Transducer and press the Transducer into position, twisting left and right while applying downward pressure to ensure a perfect full face contact with the hull and that there are no air cavities.



6. Tape Down

Carefully tape the transducer into position. The transducer must not move during the curing process so it is critical that the transducer be taped tightly in place. Curing should occur over a period of 24 hours, please allow longer in cold climates. After curing remove tape and run the transducer cable.

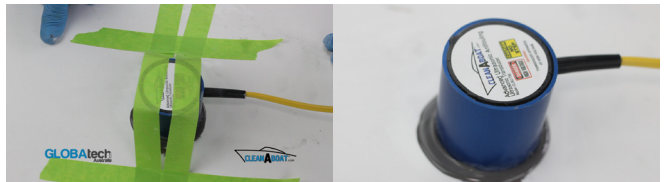

3. Installation of the Control Module & Running of Cables

Control Module Positioning

The Control module should be mounted vertically upright, positioned away from direct sunlight, where possible the control module should be installed in a cool dry place not too far from the chosen power supply.

Running 12 / 24VDC Power Cable and Protection Fuse

It is recommended that the system be wired directly to the Battery. A safe and secure cable run to the battery should be achieved, if possible avoid extending the provided 5m of battery cable. The power supply must be installed with an in-line fuse or circuit breaker with a 10A fuse/rating. A Smart battery charger should be used to maintain 100% battery power at all times. Do not install the in-line fuse until the system is ready to be powered on. See Powering on and System Checks.

It is advisable to avoid a power source that has high load electronics attached.



Running Transducer Cables(s) and Termination

It is recommended to use flexible conduit where possible to protect transducer cabling. Choose safe, dry cable runs. If extension of the transducer cable is required the cable should be no more than 25m total length. At the cable join colour / polarity should be maintained (red to red, etc), the join should be soldered thoroughly and self amalgamating heat shrinking / tape should be used to ensure the join remains water tight, cable of the same rating should be used.

Looping of Transducer cables should be avoided. When terminating the transducer cables they should be cut to length at the Control Module.

Transducer Cables are polarity specific. This means the colour coding inside the Control Module should be followed exactly. Red to Red, etc.

Transducer cables are to be run through the provided cable gland in the bottom of the Control Module. When terminating the Transducer cables into the screw terminals inside the unit, ensure there are no frayed strands of wire exposed. Cables should be stripped back a short distance, roughly 10mm, and twisted prior to screwing into the appropriately coloured terminal and tightened. After securing the Transducer cabling neatly and checking your connection is tight, screw the cable gland tight by hand to secure the cable in place.

IMPORTANT NOTICE: Disconnect Power Supply Before opening Control Module. High Voltage inside.

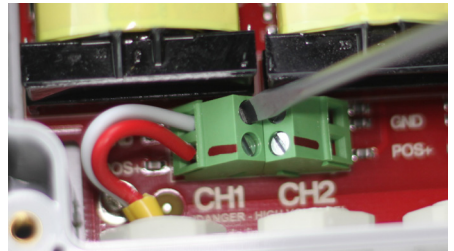
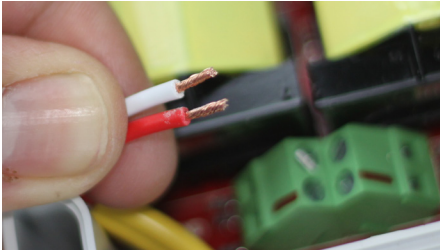

Powering on and System Checks

Prior to installing the in-line fuse and powering the system on all transducer cables should be terminated correctly and secured neatly. Once complete, install the control module lid being careful to plug the lid cable in as shown, tighten the 4 retaining screws then install the in-line fuse. At this stage the system will automatically power up and perform a quick system check before automatically beginning protection. It is advisable to check the status of the transducers by listening closely to each individual transducer for the faint click sound when the transducer is operating, this will generally be a few short clicks once every second.

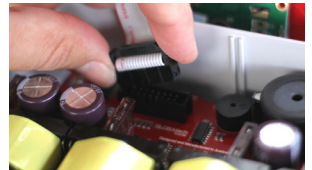

Be careful when removing the lid connector.

Wiring Diagram

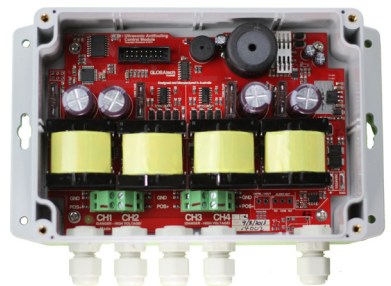
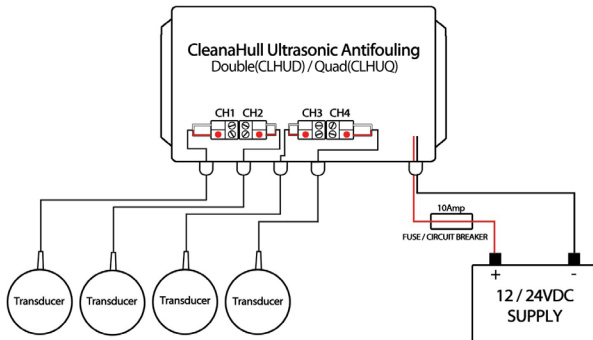

4. User Manual / General Operation

System Smarts Overview

The CleanAHull Advanced Ultrasonic Antifouling system utilises a smart micro controller and drive circuitry, unlike any other Ultrasonic Antifouling device available. Through the use of; multiple temperature sensors to monitor everything from drive circuit to power supply, multiple voltage sensor monitoring to ensure input voltage and internal voltages are within safe specification, multiple fuse sensors to determine individual channel fuse status. The CleanAHull system operates while constantly checking, monitoring and maintaining it's own safe working environment to maximise protection of your vessel while ensuring longevity of it's own parts, it will even shut off the output and shift into low power mode if your battery runs low so as to ensure there is no over drain on your batteries.

If there is any issues at all the CleanAHull system will give you a detailed error message on the System Status screen to make troubleshooting a breeze.

LCD Display

The LCD Display on the front of the control module provides up to the second details on the status of the system. This is very useful in determining the current health, internal temperature status, error states, average current consumption, input voltage, etc.

Understanding the LCD Screens

To cycle through the status screens, use the LCD button on the front face of the module. Shown below is an explanation of each

System Status Screen

This screen will display the current system status including any errors that are current

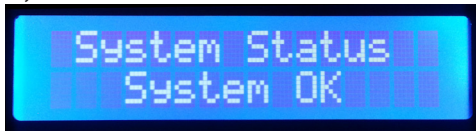

Battery Status Screen

This screen will display the current Battery Input voltage and the average current consumption in mA (milli Amps).

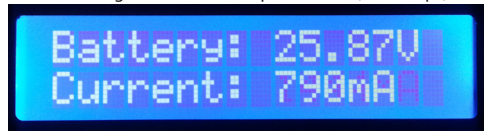

Temperature Status Screen

This screen displays the current temperature of the PSU(Power Supply Unit) and the Drive Circuitry.



Transducer Fuses Status Screen

Shown here is the status of the individual Transducer Fuses inside the Control Module. Tick = OK. Cross = Error.

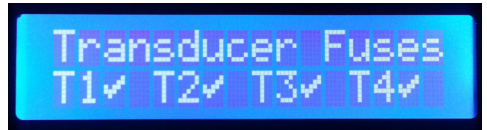

Status LED & Audible Alarm

The CleanAHull system uses a flashing multi- colour LED to display the current system status at a glance without the need to read the LCD screens. Shown here is a key of the Status LED. During any error state the Audible Alarm will sound.

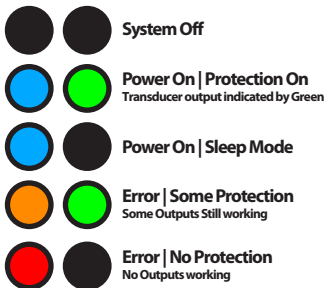

Button Functions

The CleanAHull system utilises 3 buttons on the front face to control the module. Below is the basic function of each button.



Power Button

The power button is used to turn the device on and off.



LCD Button

The LCD button is used to cycle between screens. This will also turn on the LCD back-light if it has timed out.



Sleep Button

The sleep button is used to put the device to sleep for 3 or 6 hours. Press once for 3 hours, twice for 6 hours. Press once to cancel.

Additional Functions

In some circumstances there may be a need to silence the audible alarm for a period of time, to do this hold the LCD button and press the Power Button, there will be a two fast beep sequence which indicates the audible alerts will be silenced for 12 hours. Each system stores a number of time variables to keep track of protection timers, error timers, etc. To view these values, turn the unit off using the power button and then press the sleep button. To cycle through the available screens use the LCD button, to exit this menu press the power button.

5. Troubleshooting

The system fails to power on

Check in-line fuse is OK. Check Battery voltage is OK. Check the positive and negative cables are connected to the correct pole. Check the LCD connector inside the unit is connected (remove in-line fuse before removing control module front).

Transducer wasn't clicking when I checked it

Check closer to the transducer. Ensure the system is turned on and there is no errors displaying on the screen. If problem persists switch the unit off and remove the in-line fuse, then check the termination of the corresponding transducer wires inside the module, being careful to follow the polarity colouring. If persistent ensure no damage to cables.

LCD Error Status Explained

-CHECK INT FUSES

Check Internal Fuses, inside the enclosure resides a fuse for each transducer output. The Transducer Fuses screen will indicate the fuse requiring replacement, replace with the same rated fuse (7.5A)

-LOW BATTERY

The system is in Low Battery mode, check your battery charger is operating / check your battery is OK.

-OVER TEMPERATURE

The system is experiencing an over temperature situation, ensure the local environment is cooled. If the error continues consider moving the module to a cooler location in your vessel.

-OVER VOLT

The input voltage is above the specified input range. Fix this immediately. Check your battery charging system.

-PSU ERROR

There is a Power Supply Error within the module, turn the module off and remove the in-line fuse, check the internal fuses, wait 30 seconds before powering back on. If problem persists contact CleanABOat

A transducer fuse continues to blow

Check for any foreign interaction or damage to the cable for the transducer, the transducer fuse blowing can indicate a break in the cable causing a short. Ensure there is no frayed wires across the terminals inside the control module (switch off and remove the in-line fuse before opening the module).

I get over temperature errors often

Typically the system should never enter Over Temperature state, this usually indicates the chosen location of the module in the vessel is in a hot environment. Try controlling the temperature in the immediate area or moving the control module to a cooler location.

I get over volt errors often

The over volt state is achieved when the input voltage exceeds 30VDC. This indicates your charge circuitry is providing too high a voltage. Check your engine charge function and battery chargers / solar charge regulators immediately. While in over volt there will be no Ultrasonic Protection.

I get low battery errors often

It is important that a good steady battery supply is provided, check your battery charger and battery function, ensure no other high drain accessories are sharing the same power supply and potentially causing a low voltage while they are on. While there is a low battery error present there will be no ultrasonic protection.

Please visit www.CleanABOat.com for more help and troubleshooting tips.

6. Maintenance

It is recommended that the system be checked regularly to ensure active Ultrasonic Protection. Also that the vessel is used frequently to assist in the removal of any dead algae, slime and debris buildup. Using a soft bristled broom it is recommended to clean away dead algae, slime buildup at the waterline regularly.

7. Warranty Policy

Globatech Australia products are warranted for a period of 24 months against faulty materials and/or workmanship from date of sale or a maximum of 36 months from the date of manufacture subject to the following terms and conditions:

- The goods must be installed and operated in accordance with the manufacturers recommendations and instructions set out within this guide.
- In the event of a claim the goods are returned to the manufacturer with a copy of the merchant invoice.
- In the event of a claim any associated expenses including but not limited to; diagnosis, removal, and/or installation of the goods is the responsibility of the client including any freight costs.
- The warranty shall be void where the goods have been used for a purpose for which they are not intended, or altered in any way that is detrimental, or opened or tampered with by an unauthorized party, or damaged by mechanical abuse, or damaged by transient voltages, or damaged by over voltage, or contaminated by water or other substances, or damaged by incorrect application.
- Save and except for the express warranty set out above and to the maximum extent permitted by law, all conditions and warranties which may at any time be implied by the common law, Trade Practices Act, Fair Trading Act or any other State or Federal Act are excluded. To the extent that these cannot be excluded and where the law permits, the manufacturer in respect of any such condition or warranty shall be limited at their option to the repair or the replacement of the goods or the supply of equivalent goods or refunding the cost of the goods.

Installer Details:

Installation Date:

Notes: